

250-8901A

Mobile Video Recorder

User's Manual Installation Manual

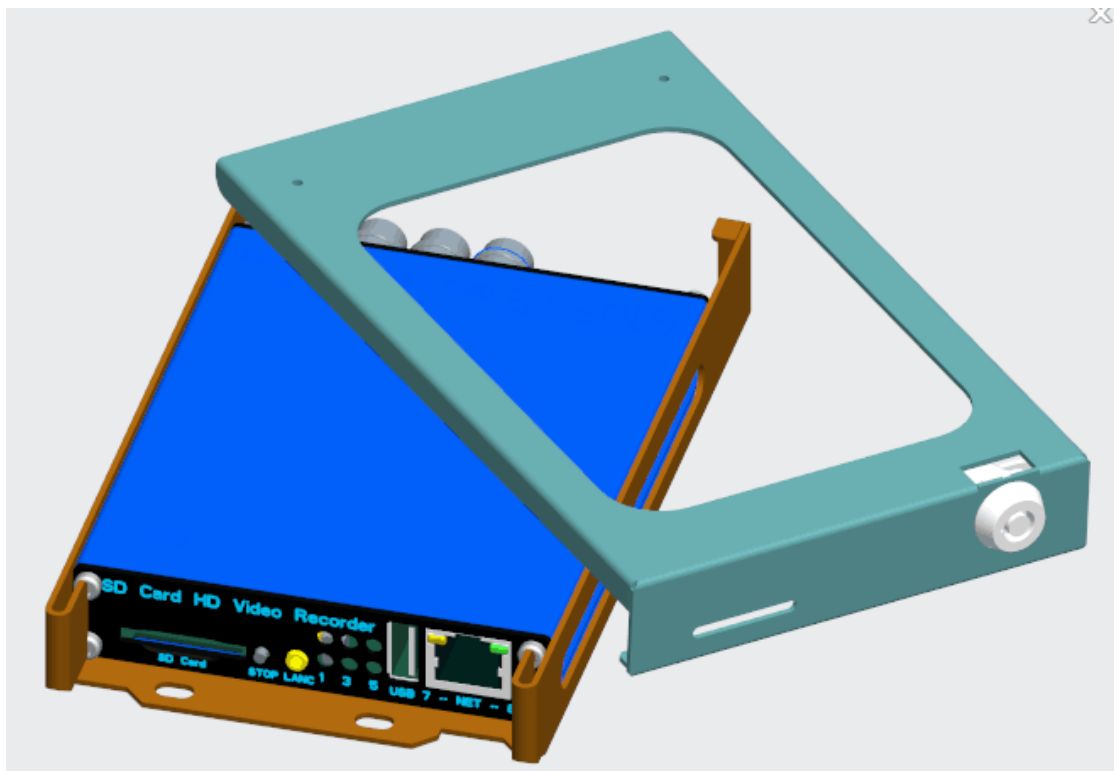

Thank you for using our Video Recorder. This manual is applicable for the 250-8901A Recorder; Please read this User's Manual carefully to ensure that you can use the device correctly and safely. The contents of this manual are subject to be changed without notice.

Warning

This device is NOT waterproof or designed to be mounted/used outdoors; to prevent damage do not expose the device to moisture, or extreme temperatures.



This lightning flash with arrow symbol within an equilateral triangle is intended to alert users that there might be uninsulated dangerous voltage which may cause electric shock to person when the cover of device is opened.

CAUTION

RISK OF ELECTRIC SHOCK

DO NOT OPEN

To prevent from the risk of electric shock, do NOT remove top cover or back cover. There is NO user-serviceable parts inside.



The exclamation point within an equilateral triangle is intended to alert users the important operating and maintenance(servicing) instructions in this manual.



Important notice:

1. Please read this manual and all cautions before installation / Use.
2. Please keep this manual for reference in the future.
3. Please notice all the warning information.
4. Please strictly follow the instructions in this manual while operating.
5. Do Not expose the device to wet, dusty, or dirty environments.
6. Please do NOT use abrasive chemicals, cleaning solvents, or strong detergents to clean the device. Wipe the device with a soft and dry cloth.
7. Do not mount the device in the direct path of a heat or AC vent.
8. Do not mount the device in an area of direct sunlight.
9. Use only the included accessories to ensure proper operation.
10. The device must only be installed horizontally. G-shock sensors may not work if mounted differently.

TABLE OF CONTENTS

1. General Introduction	4
-------------------------------	---

2. Product Description.....	6
2.2 Rear Panel	7
3. Start to use mobile DVR	8
3.1 Install and fix the cradle.....	8
3.2 Insert a SD card	8
3.3 Install the top cover of the cradle	8
3.4 Connect with cameras	9
3.5 Connect with power	10
3.6 GPS connection (Optional).....	10
3.7 Connect with control panel (control panel is optional).....	11
3.8 Connect with monitor	12
3.9 Format the disk.....	14
3.10 Setting up the cameras	15
3.11 Record Setting	16
3.12 Power Setting.....	17
3.13 Motor Setting	19
3.14 GPS Setting	20
3.15 G-Sensor.....	20
3.18 Network Setting.....	211
3.19 Server Setting	222
3.20 System Setting.....	222
3.21 Alarm Setting	233
3.22 Set Date and Time	244
3.23 Output Setting	244
3.24 Record Play back.....	255
3.25 System Information	266
4. Specification	27
5. Trouble Shooting	29
6. Packing List	31

1. General Introduction

The Mobile SD video recorder is a compact, full-featured recording system that uses an SD card as a storage device. The recorder unit and associated accessories are specifically designed for operation in a mobile environment.

The Mobile SD video recorder system, used in conjunction with cameras, records up to four channels of full-motion video and audio data to a removable SD card. The firmware-driven menu system provides a simple method for configuring the unit's operation as well as searching for and viewing previously recorded AV records.

Regulatory Compliance

The Mobile Video Recorder complies with CE and Part 15 of the FCC interference limits for Class B digital devices FOR MOBILE, HOME, OR OFFICE USE. These limits are designed to provide reasonable protection against harmful interference. Operation of this device is subject to the following conditions: (1) This device may not cause harmful interference, and (2) this device must accept any interference received, including interference that may cause undesired operation.

Product Description

Product Main Features

- An embedded operating system, assuring reliability, and system integrity.
- Records up to four channels of full-motion color video with corresponding audio tracks.
- H.265 High Profile video compression.
- Total Record resource up to 30 frames/second for each channel.
- Lockable security enclosure.
- Front panel USB 2.0 port for recording to a flash card as an optional storage device.
- Ignition sense that provides DVR power-on in recording mode when the vehicle is started.
- Power-off delay record when the vehicle is shut-down with operator-selected delay times.

Video And Audio

- H.265 High Profile video compression, real-time recording 30 fps for each channel. Frame rate adjustable for each channel.
- Audio compression: G.711 codec. This codec offers high compression with high-quality audio.
- Four channels for analog cameras.
- Local video and real-time audio playback.

GPS Time Synchronization & Time Zone

- Synchronize the DVR system time with GPS automatically (When equipped with 250-8902 GPS)
- Support All Time Zones Worldwide
- Support DST (Daylight Saving Time)

Power Management

- Reliable power management, wide voltage: +8VDC~+32VDC;
- The recorder provides each camera with stable +12V DC power;
- Auto-protection for damaged camera wires.
- Can use ignition to control the power.

-
- Selectable Battery Voltage Monitor after Ignition is turned off, and auto into sleep mode when voltage is below a specified level.

Recording mode

- Continuous recording.
- Supports scheduled recording.
- Supports alarmed recording.
- Supports motion detection recording.

Speed and Vehicle status recording

- Record vehicle speed (when using GPS receiver) and car id with audio and video.
- Supports three independent sensors, can be connected to reverse, right turn, left turn, etc.
- Over-speed alarm (when using GPS receiver).
- The specified screen can be full screen displayed when reverse, left, or right sensors are triggered.

2. Product Description

2.1 Front Panel

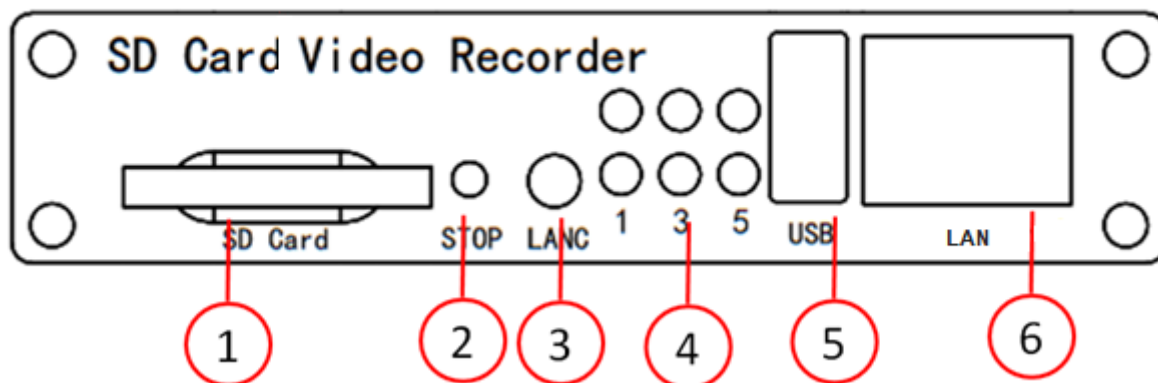

- 1: SD Card Slot
- 2: Stop Button
- 3: Panic Button Connector
- 4: Indicator LED's (1: SYS 2:4G; 3: SD 4: ALARM; 5: PWR; 6: RUN)
- 5: USB Connector
- 6: Network Connector(RJ45)

Get to know the status of the DVR system by the indication of LED lights:

5. PWR	6. RUN	Description
Always on	Blinking	DVR is on & running
Blinking with RUN With triggers enabled	Blinking with PWR With triggers enabled	Ignition is not enabled, and the DVR is OFF.
Blinking together with RUN	Blinking together with PWR	Ignition signal is not enabled & DVR is running. The unit will turn OFF when the "Delay Time" setting is reached.
Blinking every 3 seconds	Off	DVR is off. The lock is in off state and user can use key to turn on the DVR
1. SYSTEM	Description	
Always On	4 cameras recording together	
Blinking	Blinking every 2 seconds. The number of blinks is the number of the camera not connected. For example, if it blinks 3 times, it means there are 3 cameras not connected.	
Off	Not recording and no cameras connected.	

2. 4G	Description
Not Used	

3. SD	Description
Always On	Disk in use, Recording or Playing.
Off	Disk not in use

4. Alarm	Description
Always On	DVR has alarm report (Collision, e.g.)
Off	No alarm

2.2 Rear Panel

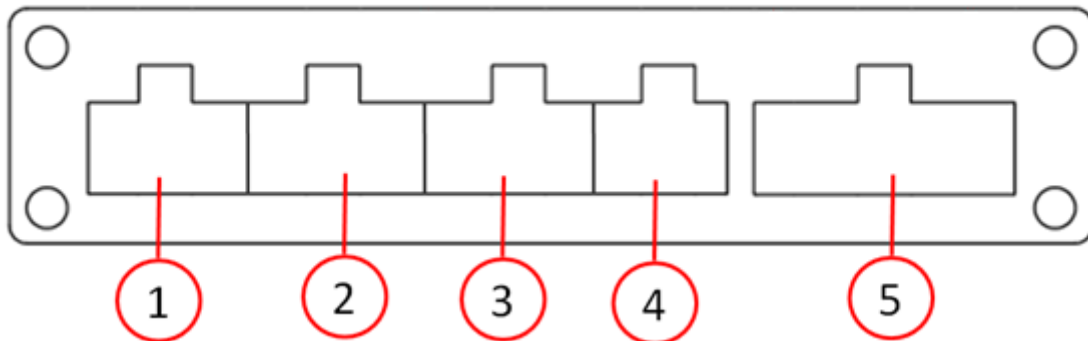

- ①: Power (including Power, Ground, Ignition).
- ②: Camera 1 and 2 (including power for the camera)
- ③: Camera 3 and 4 (including power for the camera)
- ④: CVBS Video and Audio Out (including power for the monitor)
- ⑤: 3 sensors, 1 RS232 (For GPS), 5V DC output, 1 LANC input

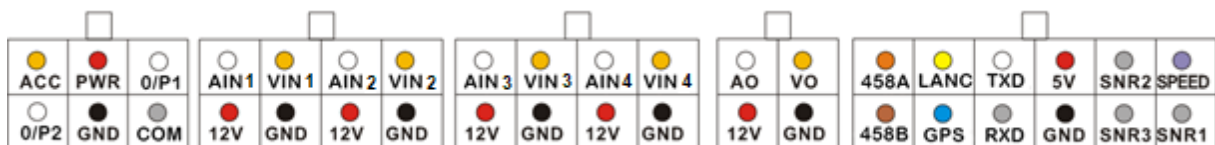

3. Start to use mobile DVR

3.1 Install and mounting the cradle

Use a power drill and screws to mount the cradle in the right place inside the vehicle.

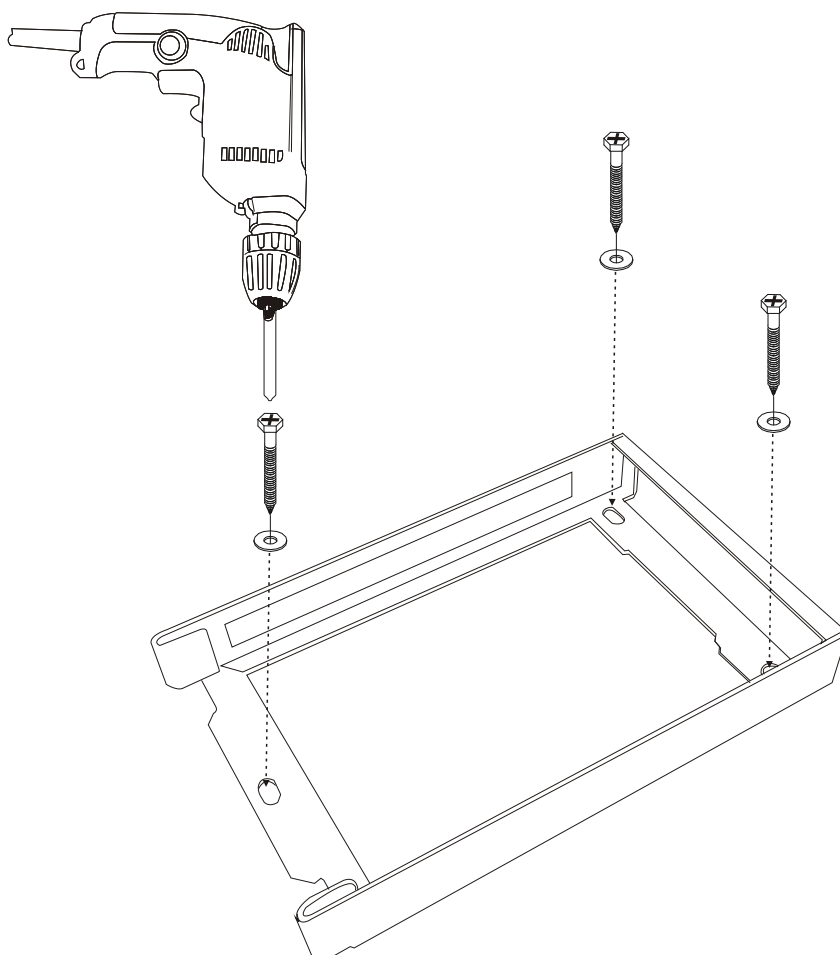

3.2 Insert an SD card

Put an SD card into the card slot, recommended is a 256GB Class 10 SD Card.

3.3 Install the top cover of the cradle

Put the top cover into the cradle and use the lock to secure it.

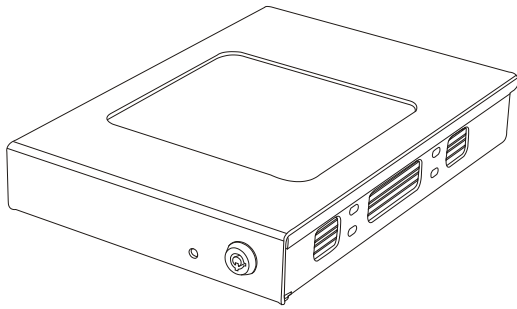

3.4 Connect with cameras

The SD DVR is compatible with analog cameras. The analog cameras can be connected using the 4-pin threaded connections on the cables we provided.

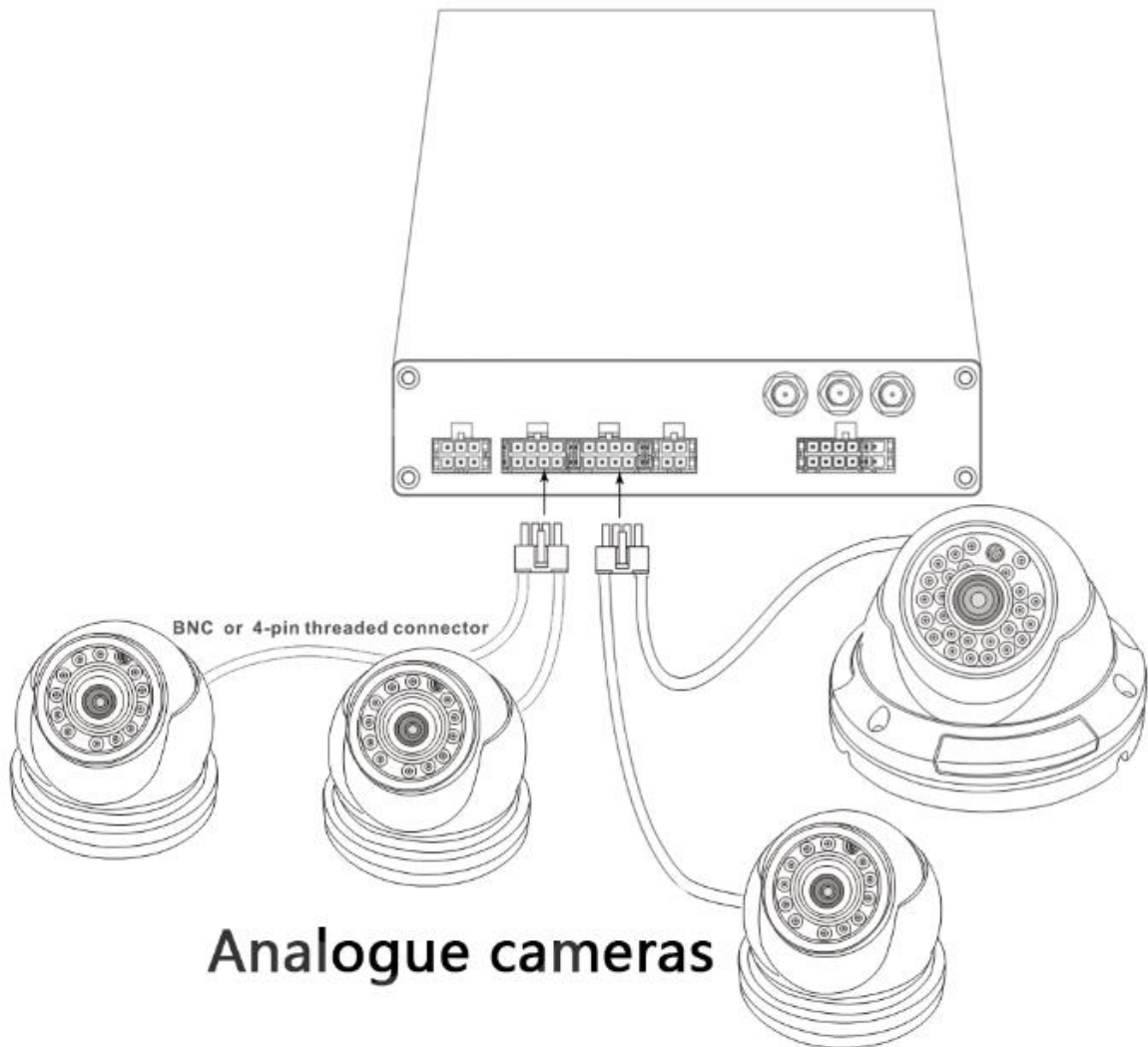

The DVR unit will provide stable 12V DC power to each camera, and record video and audio (if the camera has a microphone built-in).

3.5 Connect power

Connect the red wire to the positive pole of the battery and connect the black wire to the negative pole of the battery. Connect the yellow wire to the ignition signal (+DC) of the vehicle. The fuse should be connected to the positive pole and red wire. Please note: the fuse is used for protecting the DVR, so the fuse should be placed AS near to the battery positive pole as possible.

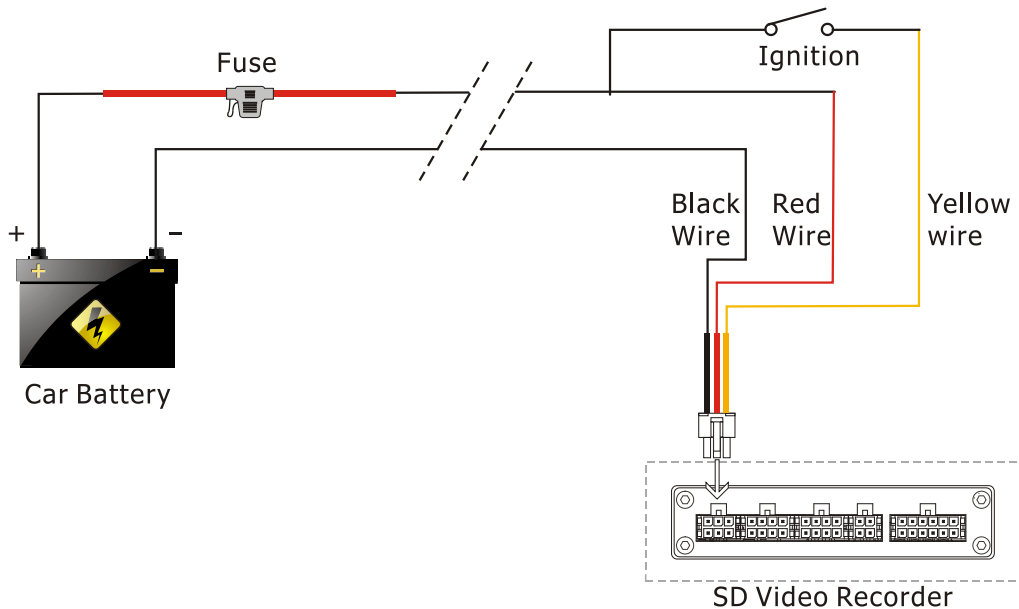

NOTE

1. The DVR uses a DC power input only; please be very careful when connecting to the "+" and "-" of the power supply.
2. Wide voltage range of 8V-32V for the DVR. The DVR may be damaged if the voltage is outside of this range.
3. Power consumption of the DVR can be 60W when the engine starts. All the cables for connecting from power to the DVR should be thick enough for current over 5 Amperes.

3.6 GPS connection (Optional 250-8902)

Connect the GPS receiver to the GPS connector on the cable harness.

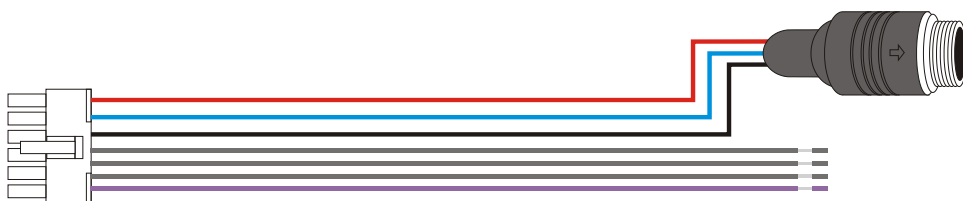

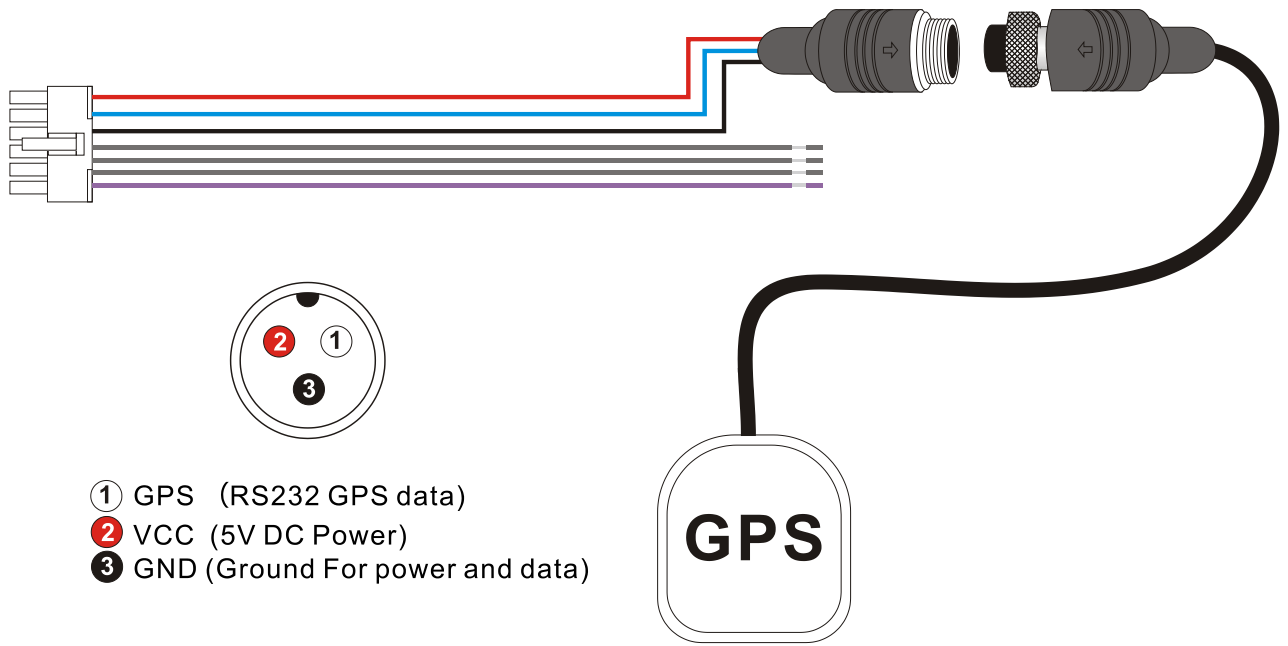

3.7 Panic Button Connection (Optional 250-8904)

The panic button can be used to capture an event or to toggle the screen display among different cameras. The control can also show the status of the DVR, including error status when the DVR is installed in a place which is hard to reach.

The button can work as either one of the following three functions:

Panic button: The button can be used as a panic button. When this button is pressed, the recording will be marked as alarm recording and this record file will not be overwritten.

Start/Stop record: The button can be used as a Start/Stop record button.

Toggle cameras: The button can be used for toggling among cameras.

The status indicator will show the status of the DVR, as the following table:

TYPE	STATUS	DESCRIPTION
RECORD	Green Light Always On	Recording
	Green Light Blinking	No recording
POWER	Yellow Light Always On	DVR is on
ERROR	Red Light Blinking Fast	Panic button is pressed
	Red Light Blinking Slowly	No disk found

3.8 Connecting to a monitor

3.8.1 Connect the DVR to the monitor input with the included 4-pin adapter.

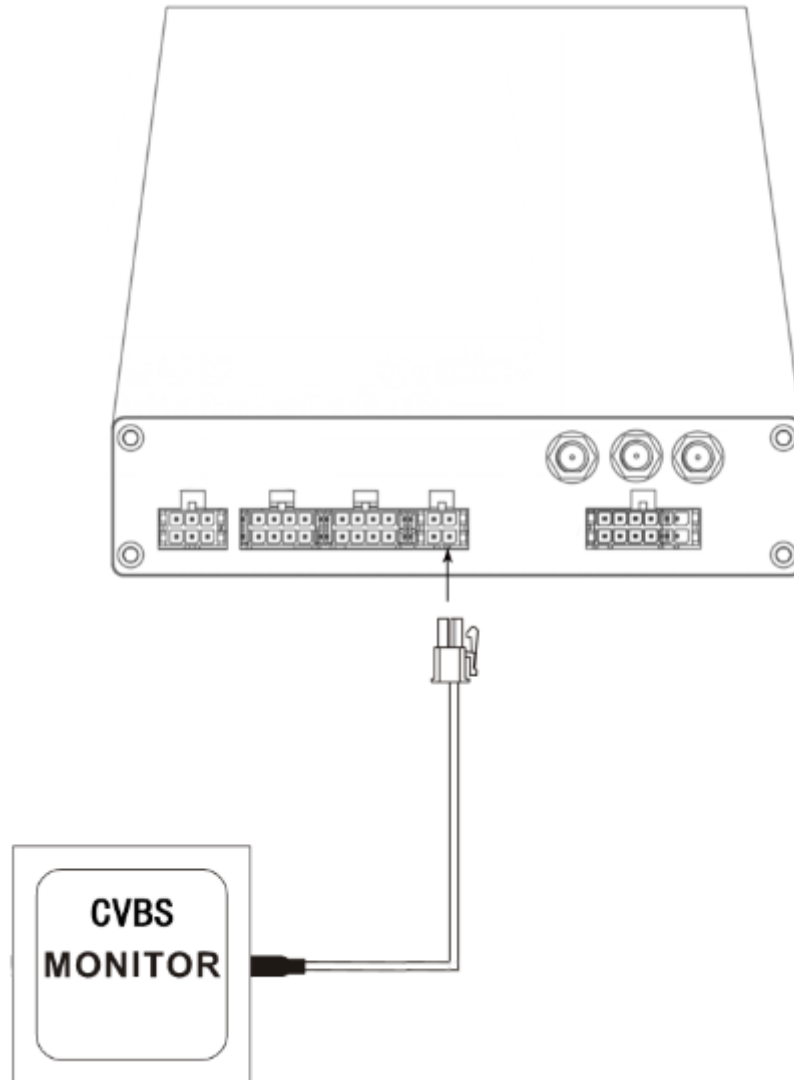

3.8.2 Preview Cameras



- 1) When the DVR is turned on, the DVR will display a preview screen automatically. Right click the mouse to show the menu. Select the desired Screen Display from the choices.
- 2) To select the function of the Panic Button (optional) select system settings >Alarm Details > Event Button.

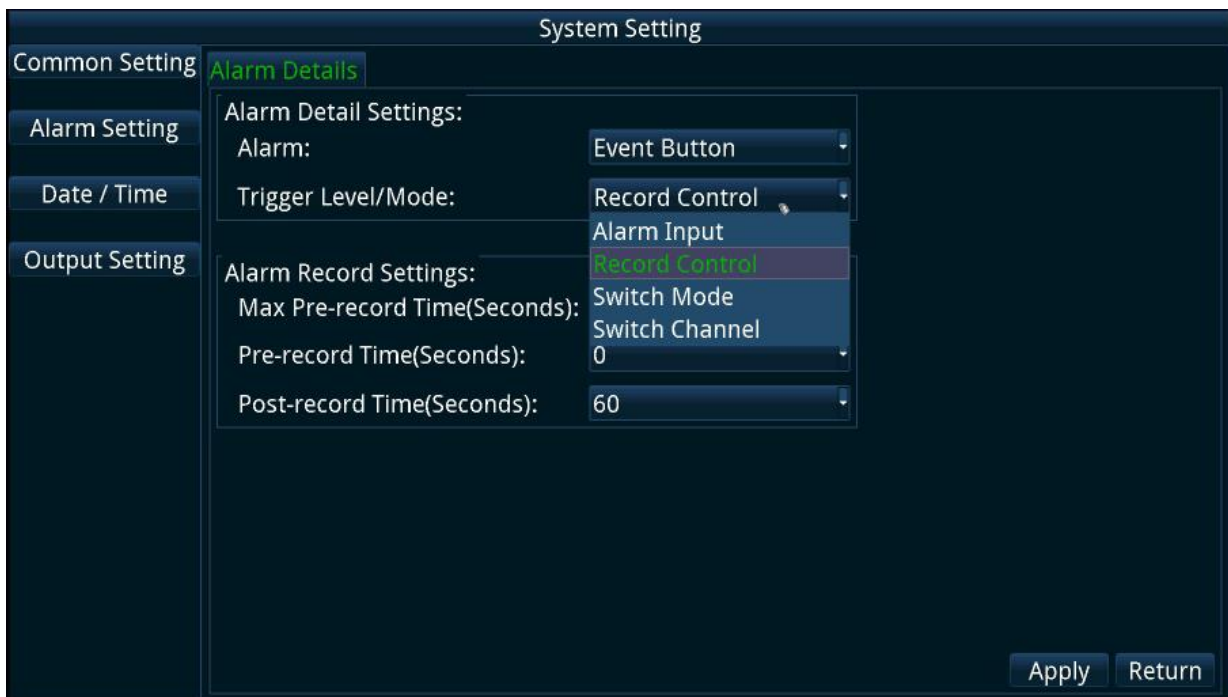



Alarm Input will set the button to Lock a recording.

Record Control will set the button to toggle through record modes

Switch Mode will change viewing modes

Switch Channel will toggle through camera channels

3.8.3 Audio output

The DVR supports real-time audio output, user's can click on the small audio icon  to start or stop the audio recording. The  icon means that real-time audio output is ON, the  icon for the real-time audio output is OFF. Audio output device is set by the "Output Device" setting in the menu.

3.9 Formatting the SD Card

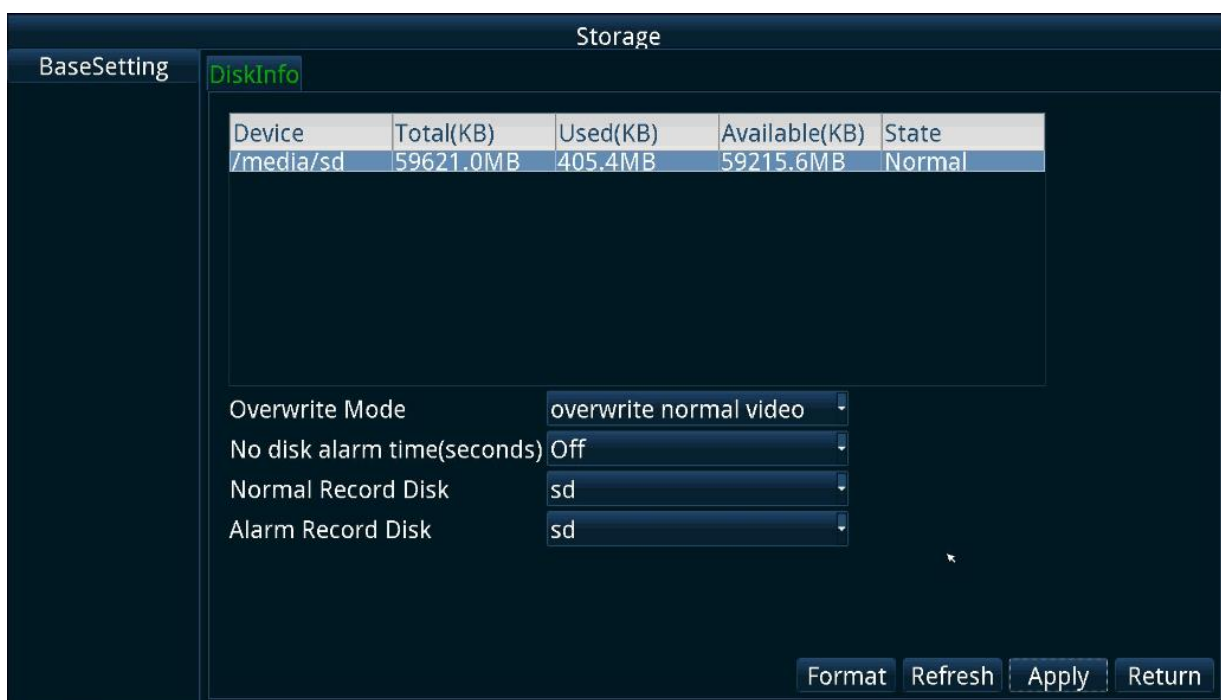

1. When the SD Card is used in the DVR for the first time, it should be formatted.
2. Right click the mouse and choose "main menu," then choose "storage." Choose the disk you need to format and click the "format" button to format the disk.
3. If no disk is found, the DVR will show a "no disk" error message. If there is some error on the disk, such as write error, the error message will also be displayed.
4. When the disk is full, the DVR can be configured to overwrite the earliest file.

Note: The format operation will delete all of the data on the disk. Please backup all of the data on the disk before formatting the disk.

3.10 Setting up the cameras

3.10.1 Camera Settings

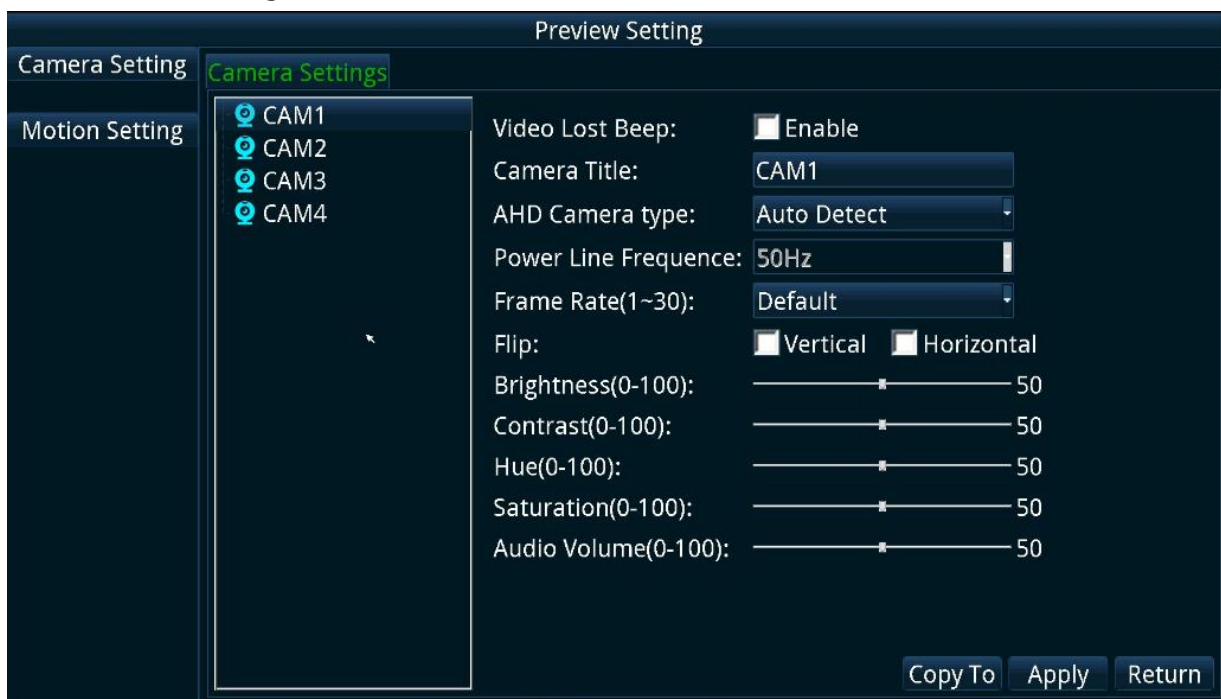

- Video Lost Beep: If the camera is damaged or disabled the DVR will beep.
- You can choose to set the parameters of "CAMx", including Camera Title, Frequency, Flip Mode, Brightness, Contrast, Hue, Saturation, Audio Volume, etc.
- The Camera Title should be less than 16 characters.
- The flip mode can be Vertical or Horizontal.

3.10.2 Motion Detection

Please note: Only the Some camera models support Motion Detection function.

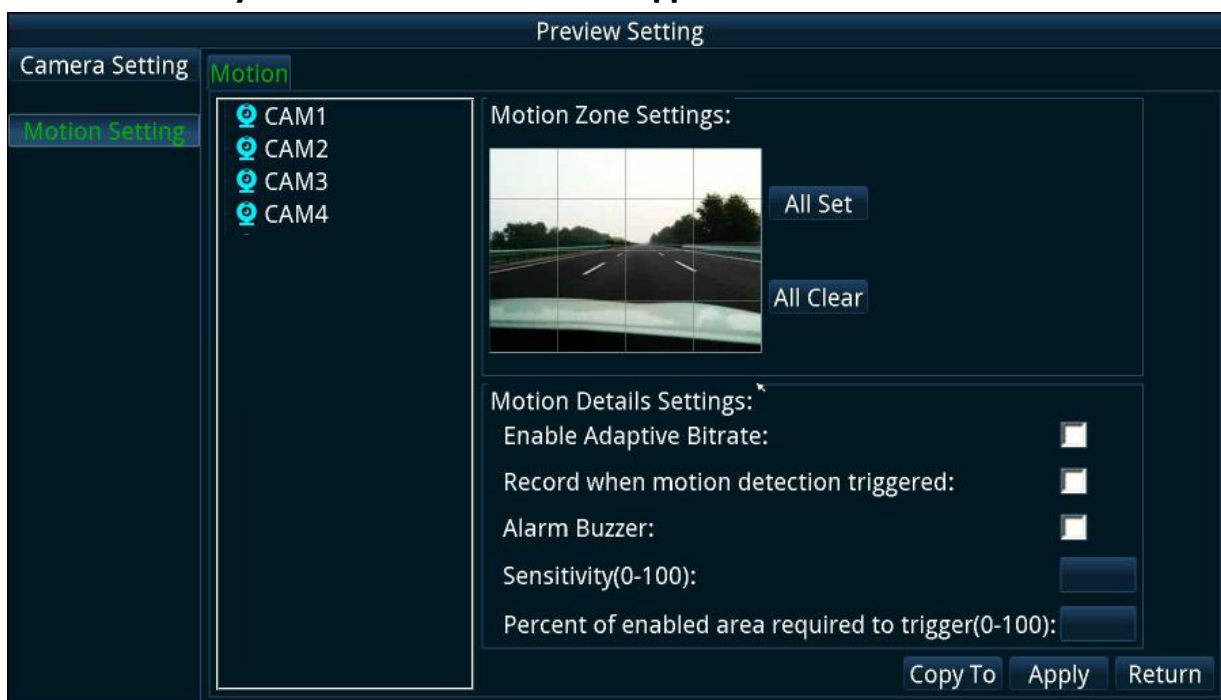

- User can set motion detection area.
- DVR can be set to use Adaptive Bitrate to get better video quality, can be set to start recording when motion is detected and can be set to trigger beeper when motion detected.
- User can set the sensitivity of the motion detection. The higher the value is, the more sensitive the DVR will be.

3.11 Recording Settings

3.11.1 Setting Record Details



- Each camera input can support up-to 480P/30fps recording and a bitrate range from 100Kbps to 8000Kbps. The recorder supports adaptive bitrate control to save recording space. The bitrate can be down to only 50% of the setting value if there is not much motion in the video. For example, if the setting is 480p/25p, 1200Kbps, the actual bitrate can be down to 600Kbps if there is little motion in the video.
- If you are using high bitrate for recording on the SD card, you must use a Class 10 SD card.
- The file length can be from one minute to four hours. Due to the limit on the FAT32 file system, each file size cannot be over 2GB. When the file length is too long, and bitrate is too high, the file size could be over 2GB. In this case, the DVR will end the file and start a new file automatically to avoid this error.
- There are H264, and H265 video modes can be set. Theoretically, H265 consumes 50% less storage space than H264 under the same picture quality.
- The file size for one-hour recording displayed in the menu is for your reference. The actual file size may vary.
- The record mode supports manual/auto/off mode. The default mode is auto. In this mode, the DVR will start recording this camera when the DVR is turned on. If it is set to manual mode, the DVR will not record on this camera until the user does it manually. User can use the mouse to start record on this camera manually. If this mode is set to off, the DVR will not record on this

camera.

- Click the "start" or "stop" button to start/stop recording on this camera.
- Click the "apply" button to save the setting.
- The recording can be encrypted by checking "using encryption." If the file is encrypted, the recorded file can't be played by using other player software. You can only use the player software provided with the DVR, and a password is needed to play this file.

3.11.2 Record Schedule

- All cameras can use the same rule. Each camera can use a special rule.

3.12 Power Settings

Category	Setting	Value
Power	Ignition Level:	High
Motor	ACC Power Off Delay(seconds):	30
GPS	Sleep Delay-ACC Off(seconds):	0
G-Sensor	Sleep Delay-No Alarm(seconds):	0
	Power On At(HH:MM):	00 : 00
	Power Off At(HH:MM):	00 : 00
	Current Voltage:	12
	Power Off Threshold Voltage:	0
	Power On Threshold Voltage:	0

- Ignition Level: "Ignition Level" is the voltage level when the ignition is turned on. By default, it is "High." In some special vehicle, this value should be set to "Low."
- ACC Power Off Delay: The DVR can be set to stay on and then turn off automatically after the ignition is turned off. This value is in seconds; the default value is 30 seconds. In this case, the DVR will go to standby mode. In standby mode, the DVR will not power on again until the ignition is turned on again. After the ignition is turned on the DVR will need about one minute to boot up completely to start recording.
- NOTE: If the "ACC Power Off Delay" is set to 0, the DVR will always be on and will not turn off even if the ignition is turned off.
- Sleep Delay-ACC Off: This parameter is used to set the timeout when the DVR is going to sleep mode after the ignition is off. In sleep mode, the camera will turn off, but the DVR will be still working. This is different than the case when using the "ACC Power Off Delay" to let DVR go into standby mode. In sleep mode, as the DVR is always working, the DVR can power up the camera and start recording immediately if there is an alarm. The DVR doesn't need to boot up before recording. The "Sleep delay-ACC Off" value usually should be set to a value larger than the "ACC

Power Off Delay," otherwise the DVR will go into standby mode before going into sleep mode. If "Sleep Delay-ACC Off" is set to zero, the DVR will not go into sleep mode.

- Sleep Delay-No Alarm: This parameter is used to set the timeout when the DVR is going to sleep mode after the last alarm (event) occurred. If this value is set to zero, the DVR will not go to sleep mode even if there is no alarm.
- Timer Power On/Off: This is used to set the DVR to turn on/off at the specified time. If both values are set to "00:00", this feature is disabled.
- Power On/Off Threshold Voltage: When the voltage connected to the DVR is Higher or Lower than the Power On/Off Threshold Voltage, the DVR will turn ON/OFF. When it is set to "0", the setting is OFF.

The reason that we have two power saver modes (the standby mode and the sleep mode) for the DVR is that in some cases the DVR should resume recording immediately from power save mode. In standby mode, the DVR is turned off, and the cameras are also turned off, the power consumption will be very low. In this mode, the DVR needs about one minute to boot up before it can resume recording. In sleep mode, the DVR is still on, but the cameras will be turned off. The sleep mode will have a higher power consumption than when in standby mode but will have less power consumption than when in the working mode. A typical use for sleep mode and standby mode is for taxi application. The DVR can set "ACC Power Off Delay" to 21600 seconds (6 hours), set "Sleep Delay-ACC off" to 10800 seconds (3 hours), set "Sleep Delay-No Alarm" to 10800 seconds (3 hours). We will also connect the taxi meter signal to the "Sensor 1" (Alarm 1), and the door open signal to "Sensor 2" (Alarm 2) and these two sensors will trigger recording. With this configuration, if the taxi is parking (no ignition) for 3 hours and there is no passenger (no meter on or no door open) for 6 hours, the DVR will be in sleep mode. But during this time, if the taxi is turned on or there is any trigger, the DVR will start recording immediately. If the taxi is parked (no ignition) for 6 hours and there is no passenger (no meter on or no door open) for 6 hours, the DVR will be in standby mode.

3.13 Motor Settings

Mobile

Power

Motor Settings

Motor

License ID: 2222222

Obtain Speed : From GPS(If Any)

GPS

Speed Unit: KMH

G-Sensor

Speed Limit(KMH/MPH): 80

Overspeed Record: Set

Overspeed OSD:

Overspeed Buzzer: Off

Apply Return

GPS Antenna Required for Speed Data

- License ID: Vehicle ID Number or License Plate Number
- Select GPS for Speed Data when equipped.
- Speed Unit MPH or KPH
- Speed Limit: Sets the speed to start recording: If the over speed value is set to zero, the over speed alarm will be disabled.
- "Overspeed OSD" Enter the Speed Warning to be displayed.
- "Overspeed Buzzer" is used to turn on/off buzzer when over speed.

3.14 GPS Setting (Requires Optional GPS Antenna)

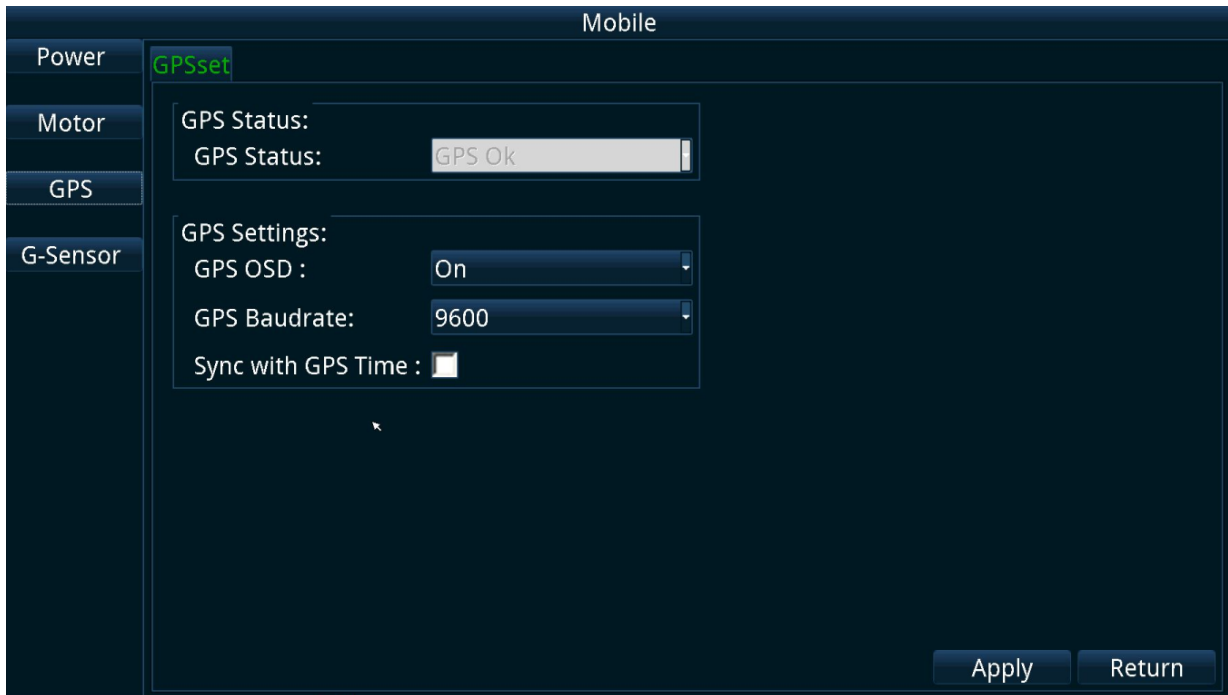

- GPS Status:
 - GPS Not Found: No GPS found on the DVR.
 - GPS Gprms: DVR got "GPRMC" data from GPS, but the GPS signal is not good.
 - GPS OK: GPS working correctly.
- GPS OSD: If this option is turned on, the GPS data (latitude and longitude) will be displayed and record with video.
- GPS OSD: If this option is turned on, the GPS data (latitude and longitude) will be displayed and record with video.
- Sync with GPS Time: When this option is turned on, the DVR will synchronize with GPS time.
- GPS Baud rate: The communication baud rate between GPS and DVR. The default value is 9600.

3.15 G-Sensor

- Instant Value: It shows the current value from G-Sensor in axis X, Y, and Z. Due to the gravity, if the DVR is put horizontally, the initial value of axis Z will have about 1.0G, and the value will be about -1024.
- Initial Offset: The "Initial Offset" is used to set the G-Sensor value at initial installation. Use this to set the device shock sensor after mounting the DVR. Select CORRECTION then Select APPLY to set the initial G-Sensor Position after mounting.
- Alarm Threshold: The "Alarm Threshold" is used to set the threshold to trigger the alarm. If the difference between "Instant Value" and "Initial Offset" is larger than "Alarm Threshold," the DVR will trigger a G-Sensor alarm.
- Alarm OSD: Set the title displayed and recorded on the screen when there is a G-Sensor alarm.
- Alarm Record: Set up the G-Sensor alarm recording.



3.18 Network Setting

- DVR supports dynamic IP and static IP.
- The network setting should comply with the network setting where the DVR is located. See your MIS tech for details. Rostra cannot supply network information for the connected network.

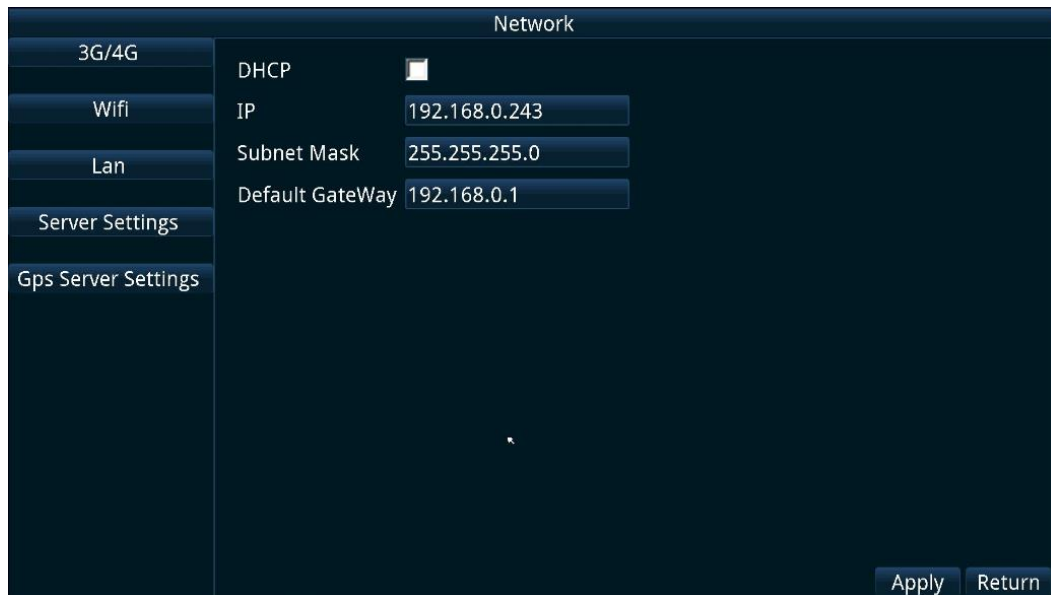

3.19 Server Setting (Not Active in 250-8901A)

3.20 System Setting

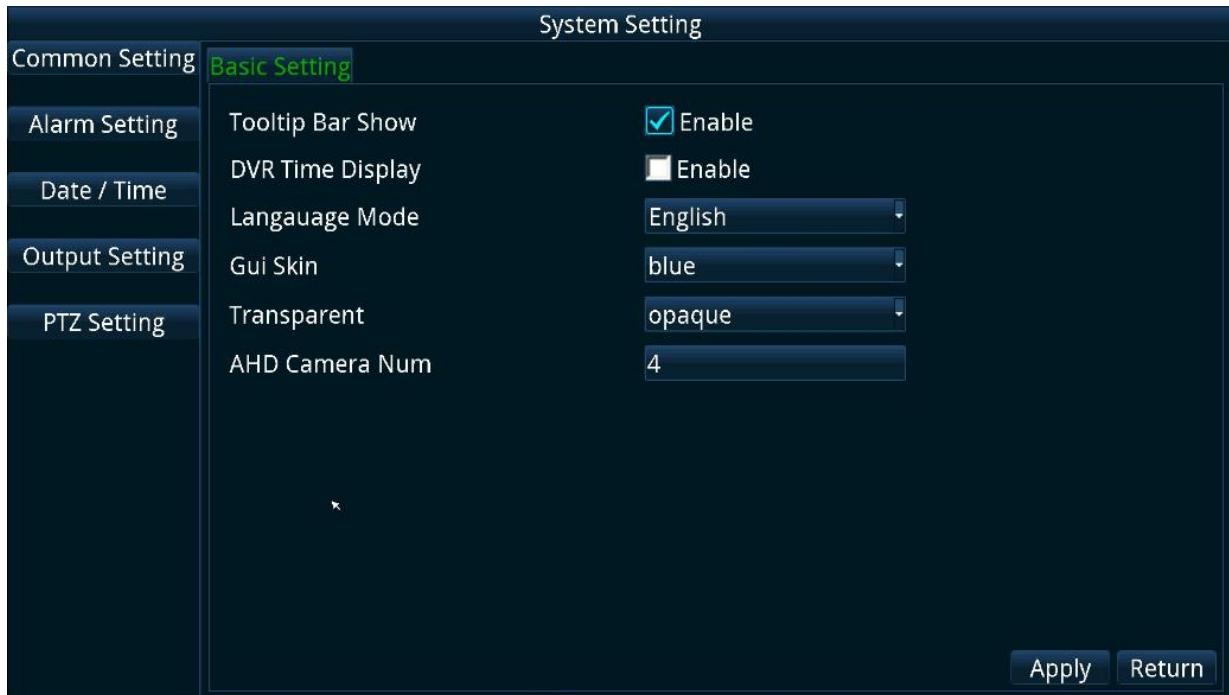

- Enable the "Tooltip Bar Show" and "DVR Time Display,". This will show at the bottom of the monitor screen
- DVR supports multiple languages.
- AHD Camera Num: Set the number of Cameras Connected (Default is Four).

3.21 Alarm Settings

The screenshot shows the 'System Setting' window with the 'Alarm Details' tab selected. The interface is divided into a left sidebar and a main content area. The sidebar contains menu items: 'Common Setting', 'Alarm Setting', 'Date / Time', 'Output Setting', and 'PTZ Setting'. The main content area is titled 'Alarm Detail Settings' and contains the following fields and controls:

- Alarm:** A dropdown menu set to 'Sensor1'.
- Trigger Level/Mode:** A dropdown menu set to 'High'.
- Alarm Record:** A button labeled 'Set'.
- Alarm Snapshot:** A button labeled 'Set'.
- Alarm OSD:** A dropdown menu set to 's1'.
- Alarm Buzzer:** A dropdown menu set to 'Off'.
- Switch View:** A dropdown menu set to 'off'.
- Switch View Delay(Seconds):** A dropdown menu set to '0'.

Below these fields is the 'Alarm Record Settings' section:

- Max Pre-record Time(Seconds):** A label above two input fields.
- Pre-record Time(Seconds):** An input field set to '0'.
- Post-record Time(Seconds):** An input field set to '60'.

At the bottom right of the window are two buttons: 'Apply' and 'Return'.

- DVR has three alarm (Trigger) Inputs. These are labeled Sensor 1,2,3, in the Alarm menu. These Triggers use the Gray colored wires on the wire harness. See the module for designation number.
- Triggers can be Positive DC (High) or Negative DC (Low).
- Trigger Level: If the trigger level is set to high, a high-level voltage on the sensor will trigger an alarm. You can check the "Trouble Shooting" at the end of this manual for the definition on the high level and low level.
- User can set up the alarm recording for these events.
- Alarm OSD: The title user wants to display on the screen and be recorded with the video.
- Alarm Buzzer: Enable/Disable buzzer when there is an alarm.
- Switch View: Choose one camera to be in full-screen mode when there is an alarm. This can be used for rear view full screen or side view full screen. For example, user can connect sensor 1 to a reverse signal, and if camera 1 is the rear view camera, we can set the "switch view" for sensor 1 to 1. In this way, when the vehicle is reversing, camera one will be displayed as a full screen on the monitor.
- Switch View Delay: The DVR will continue to show the camera selected until the alarm is not triggered for specified delay time. This is useful for the side view camera. For example, if the left side camera is camera 2, and the user connects sensor 2 to the left turn signal on the vehicle. When the driver is turning left, the sensor two-alarm will be triggered. Set the switch view delay for 5 seconds or more to remain on while the turn signal is flashing.
- Pre-Record Time: The amount of recorded time retained before the alarm is triggered.
- Post-Record Time: The amount of recorded time retained after the alarm is triggered.
- All of the alarm recorded files will be kept in a separate alarm folder; the files in the folder will not be overwritten.

3.22 Set Date and Time

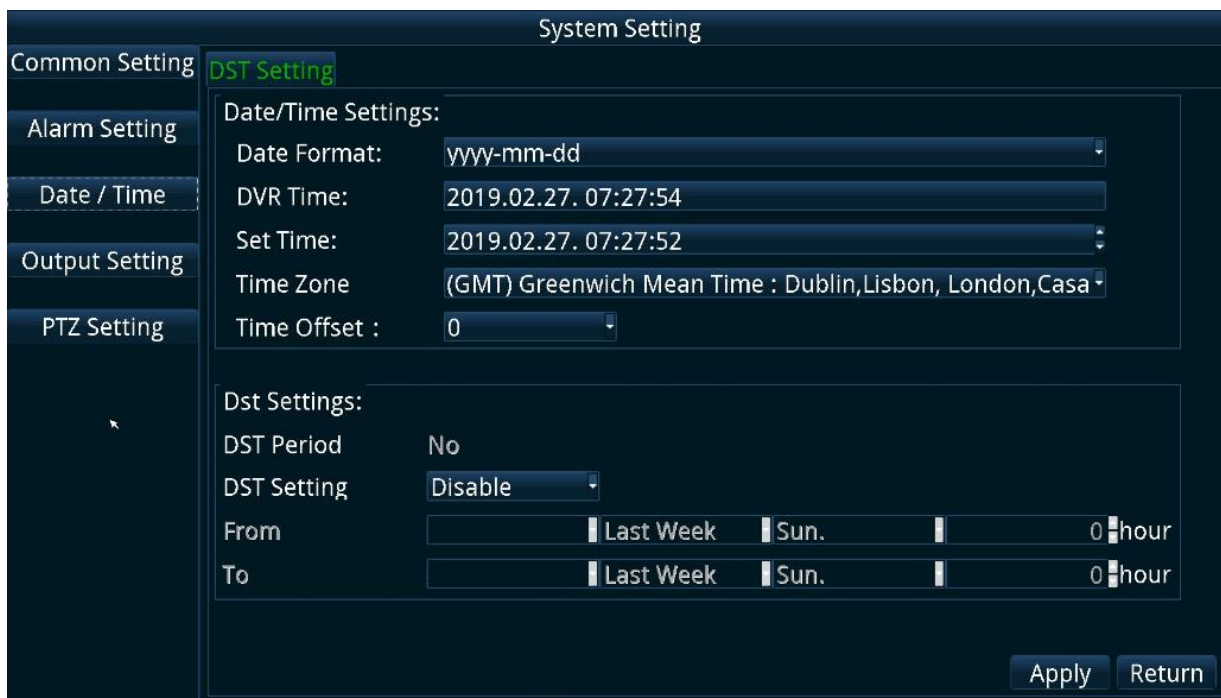

- Setup the displayed date format.
- DVR time is only used for displaying the current time. It's not editable here.
- You can set the DVR time in "Set Time." If you find the DVR time is not changed as you specified, please check to see if you have enabled the "Sync With GPS Time." Disable if no GPS.
- Select the required time zone.
- Time Offset can be used for Daylight Savings Time
- DST now supports USA/Australia/New Zealand/UK.
- Users can set up the rules for DST in their own country if the country is not listed above.

3.23 Output Setting

- The DVR can connect HDMI and CVBS monitor at the same time, and the audio output is based on the setting of the "output device." The 250-8901A only Supports CVBS Output.
- Volume adjustment out to the monitor and the time for DVR to enter Screen Saver mode can be set. When it is set to "0", the DVR will NOT enter Screen Saver mode.
- CVBS Output Reduction Value means that the user can adjust the output display pixel according to the current CVBS screen resolution if needed.

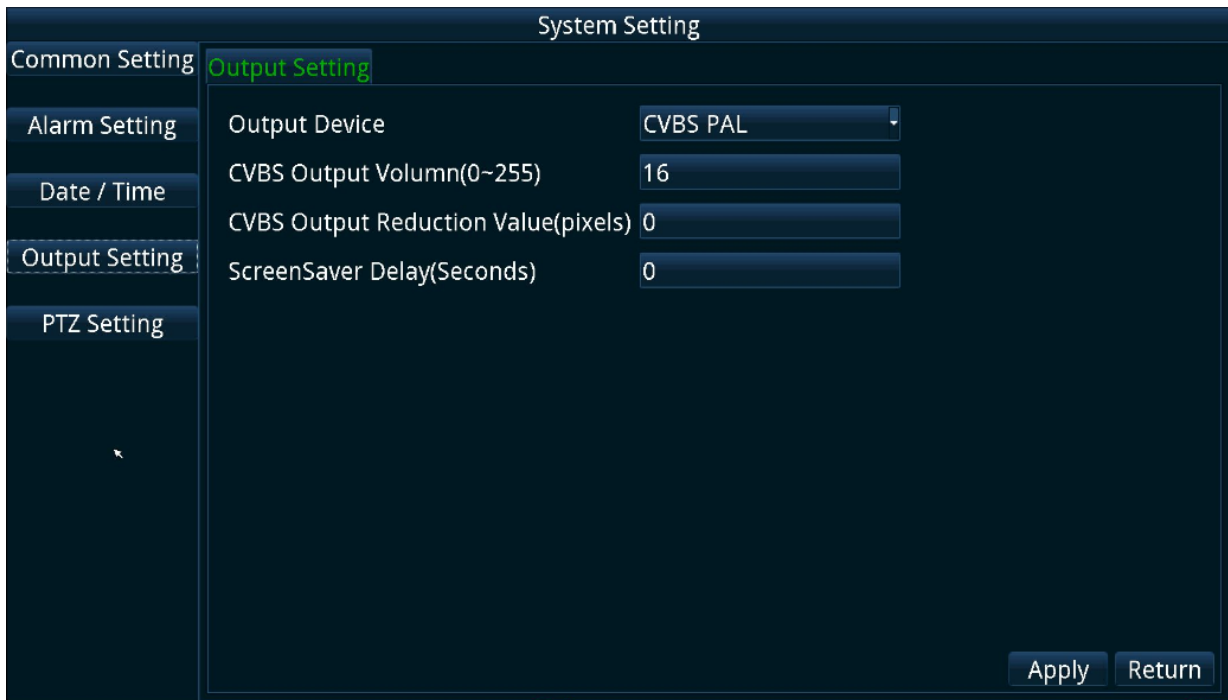

3.24 Record Play back

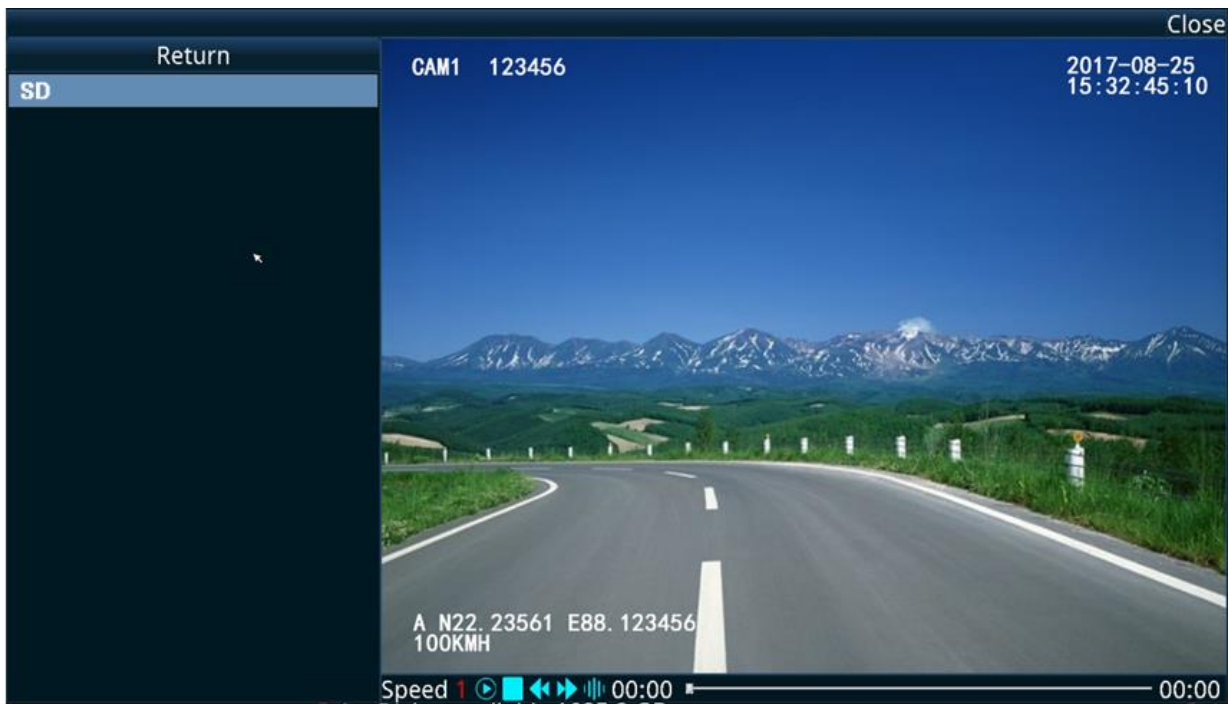

- Playing back files directly from the Internal SD Card.
- The recorded files are listed according to the time and cameras.
- When playing back, a user can fast forward, slow forward, pause, and step through videos.

3.25 System Information

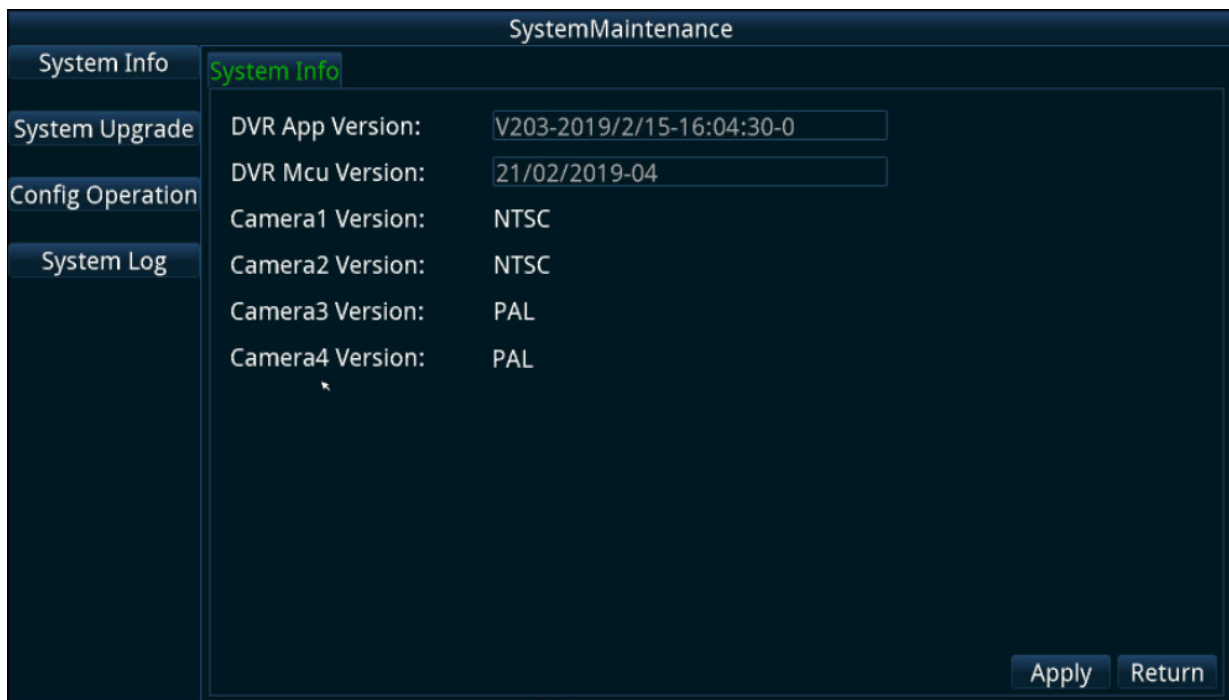

- In system information, it will display the firmware version, MCU firmware version, camera firmware version.

3.26 System Upgrade and Log

The system Upgrade and Log are used for diagnosis and repair. DO NOT attempt an update as it could damage the DVR.

4. Specification

Model		250-8901A
SYSTEM	OS	Linux 3.18.20
	Booting Time	<20 s (From Powered on to start recording)
	Language	Chinese/English/Russian
	UI	GUI
	Power	Power In: 8V ~ 32V DC, Power out for analog camera: 12V/1.5A (4 cameras)
Video	Video Input	Maximum for 4x Analog cameras(PAL or NTSC...)
	Video Output	1 Video Output (1 CVBS output)
	Preview	Support FullScreen/Dual View/Quad View
	Record Mode	Auto Record, Schedule Record, Alarm Record
	Record File	Record video and audio at the same time
	Compression	H.264 /H.265
	Frame Rate	100fps@720x576(PAL); 120fps@720x480(NTSC); or others
Audio	Audio Input	4 audio input (audio is built in the camera)
	Audio Compression	PCM
Video Process	Record Resolution	Support 720x576(PAL) or 720x480(NTSC), depends on the type of camera
	Bitrate	100~8000 kbps for each camera
	Storage	SD card up to 256GB, the video file format is AVI
Alarm	Alarm Input	Three alarm sensors (triggers) input, one speed input, one ignition input, one panic button alarm, 1 G-Sensor alarm
	Alarm Output	One beeper, Alarm OSD
	Event	Video Loss Event, Over Speed Event, G-Sensor Event, Storage Event, Motion Detection Event, Panic button Event
Communication	RS485	One RS485 port
	RS232	One RS232 port (For GPS)
	RJ45	One RJ45 port, 100M network
	USB	One USB can be used for mouse, USB stick, hard drive
Network	Protocol	TCP / IP
	3G/4G	NONE
	WIFI	NONE
Location	Location	The location feature is optional, Support GPS/GLONASS/BEIDOU, recording location, speed, live tracking
Firmware	Frame Rate	Recording frame rate: 1~30fps selectable for each camera
	License ID	Supported
	Camera Name	Supported
	OSD	Display and record time, license ID, camera name, location, speed
	Firmware	Via USB disk/SD card/

	Upgrade	
	G-Sensor	Supported
	Play back	Support play back, file listed by time, alarm
	Play Speed	Support from 1/32 to 32
Software	hPlayer	Player software, play multiple cameras together, can also play the encrypted file
	CMSV6	None
Power Input	Power Input	8VDC~32VDC
Power Output	Power Output	Power output for cameras: 10.5V/1.5A (4 cameras)
ACC	<4.5V	Ignition Off
	>6.2V	Ignition ON
Power Control	Ignition	Turn on the DVR when ignition is on, can set DVR to turn off after a specified time when ignition is off
	Power Consumption	Less 5.0W (No camera power consumption included)
Other	Size	118x92x20 mm
	Weight	About 0.2kgs
	Time	Internal clock, can synchronize with GPS when equipped
	Dual bit stream	Enabled
	Power Protection	Short/Reverse/Over Voltage
	Default	Can be adjusted
	LED Indicators	Indicator for power, run, alarm network,
	Over Write	Protection for events
	Time Synchronize	Synchronize with GPS when equipped
Working Condition	Working Temperature	-25 ~ 55°C
	Working Humidity	5%~93%

5. Trouble Shooting

1. Q: After connecting the DVR power, no video output, the first and second indicators lights are flashing alternately.

A: The No.1 and No.2 indicator light is "Power" and "Run." If the two indicators lights are flashing alternatively, the DVR has no ignition signal; please check if the yellow line of the input power lines is connected to power.

2. Q: Recording time is limited due to SD Card memory Size.

A: Reduce the video frame rate, video resolution to extend the recording time.

3. Q: when using the SD card, ScreenTip "read-only error" appears.

A: Please check if the SD card is write-protected, if so, please move the picks to the non-write protected or Replace the SD Card.

4. Q: What is a high level, what is a low level?

A: High level refers to a DC voltage from the vehicle of higher then 2.8VDC, LOW refers to a Ground or Negative DV Voltage.

5. Q: Respectively, what's the voltage reference range of the high and low level in the DVR?

A: The voltage range of low level is DC 0V~1.5V; the high level is DC2.8V~32V.

6. Q: SD cards or hard disc are OK, but the video recording doesn't work, what should I do?

A: Check the Record Mode in the settings menu and make sure it is set to "Automatic," not " Off." Check the DVR record Schedule time to make sure you have not set a time that is out of this range.

8. Q: Does the DVR support 64G and above SDXC cards?

A: Yes, The DVR does support the capacities of 64G and above SDXC cards.

9. Q: Live images or Playback images hang or stall when viewing (lag).

A: Ensure you are using a class 10 SD Card.

10. Q: Does the internal clock memory hold time if the battery is shut off to the vehicle? If so, how long will it last?

A: the Yes, The DVR internal clock memory will hold time for about one month with no power connection.

**11. Q: what kind of player software should use to play back the SD on the PC?
Why do some video's seem not to play correctly?**

A: The Mobile DVR recording files are a standard AVI format, video stream compression standard is H. 265.

1. The DVR has its player software, the hPlayer, including many special additional features, such as playing continuously, fast forward playing, and other quickly locating recording and playing. That was included on a DVD with the device.

2. The recorded files also are supported by general players such as VLC (version 1.0.0 and above, free open source software, and can be downloaded from the internet), Media Player Classic (version 2009 Build: 3.9. above), Older Storm Audio can only support for video of 720x576 - resolution, when playing high resolution (1280x1024) recorded video file of Composite Mode, it can't display all the images, images on the right and below the video will be cut-off. The player must support H.265 format.

3. For files with encryption, you will need to use the included hPlayer to view them.

12. Q: How long will my 256GB SD Card record?

A: when you are setting the recording details in the DVR menu, you can see the estimated disk usage for each camera, you can calculate the time for recording according to this data.

6. Packing List

Standard Packing List:

Item	Description	Quantity
1	DVR	1 set
2	DVR enclosure	1 set
3	DVR enclosure key	2 sets
4	AV input cable	2 pcs
5	Power cable	1 pc
6	AV output cable	1 set
7	Fuse holder	1 set
8	5A fuse	2 sets
9	Composite cable	1 set
10	Manual	1 set
12	Screws	6 pcs

Optional accessories(need to buy separately):

Item	Description
1	GPS receiver 250-8902
2	Panic Button/Control 250-8904