

**250-9009**  
**08-09 MAZDA 3**  
**AUTOMATIC**  
**CRUISE CONTROL INSTALLATION INSTRUCTIONS**

**SERVICE PART NUMBERS**

<b>ITEM</b>	<b>QTY</b>	<b>DESCRIPTION</b>	<b>PART NUMBER</b>
1	1	CONTROL MODULE	250-2746
2	1	MAIN HARNESS	250-2712
3	1	ECM HARNESS	250-2747
4	1	SWITCH	250-2721
5	1	SACK PARTS	250-2748
6	1	BRAKE SWITCH	250-2734

**CONTENTS**

**INSTALLATION.....2**  
**CONTROL SWITCH..... 4**  
**WIRING DIAGRAM..... 6**

# INSTALLATION

## A. INSTALLATION PREPARATION:

1. **DISCONNECT NEGATIVE BATTERY CABLE BEFORE INSTALLATION. FIGURE 1**
2. REMOVE THE STEERING COLUMN SHROUD AND LOWER DASH PANEL. **FIGURE 2**

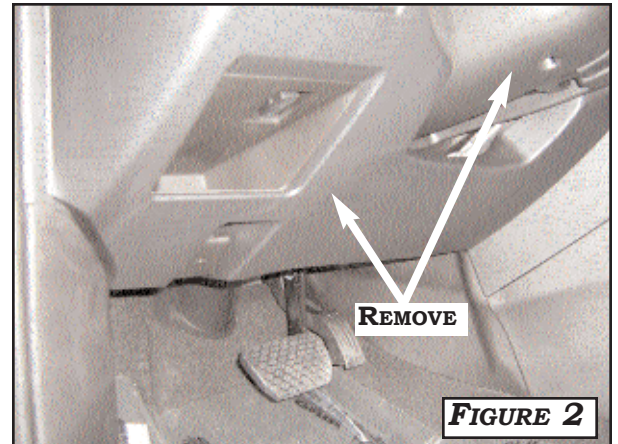
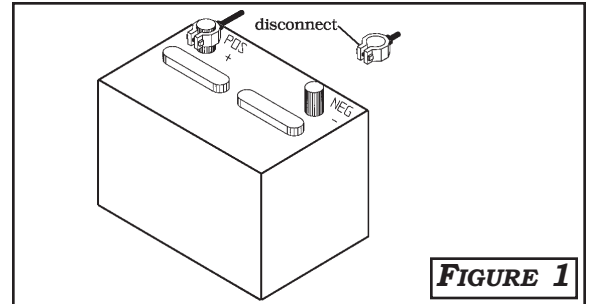

## B. HARNESS INSTALLATION:

1. LOCATE THE WHITE CONNECTOR AT THE IGNITION SWITCH. CONNECT THE **RED IGNITION WIRE (+12V IGNITION)** FROM THE MAIN CRUISE HARNESS TO THE **GREEN/RED WIRE** OF THE IGNITION SWITCH CONNECTOR. **FIGURE 3**
2. LOCATE THE YELLOW 12-PIN CLOCK SPRING CONNECTOR AT THE LEFT SIDE OF THE STEERING COLUMN.

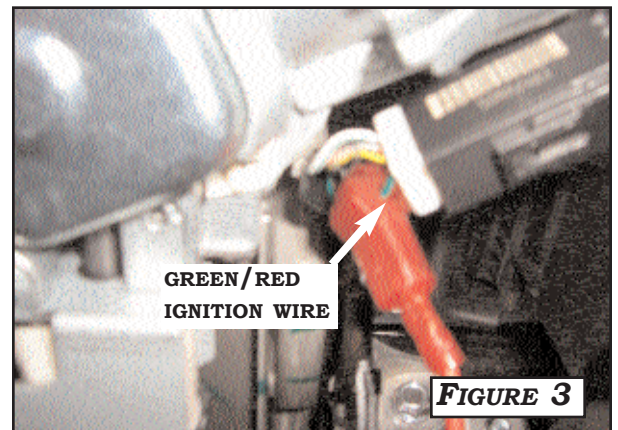

**NOTE: IF WHITE WIRE IS NOT PRESENT IN PIN 6 AT CONNECTOR, GO TO STEP C OF THE INSTRUCTIONS.**

CONNECT THE **WHITE CRUISE 1 WIRE** FROM THE MAIN CRUISE HARNESS TO THE **WHITE WIRE (+5V CRUISE)** IN PIN 6. **FIGURE 4** GO TO STEP D (BRAKE SWITCH INSTALLATION) TO CONTINUE.

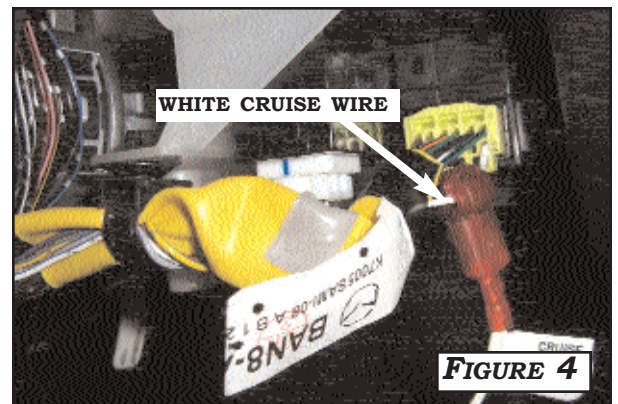

# INSTALLATION

## C. PCM HARNESS INSTALLATION:

1. IF WHITE WIRE WAS NOT PRESENT AT THE CLOCK-SPRING CONNECTOR, REMOVE THE PCM CONNECTOR (CLOSEST TO FIREWALL) AS SHOWN IN **FIGURE 5**.
2. USE A PRECISION TOOL OR SMALL FLAT HEAD SCREW-DRIVER TO RELEASE THE RETAINER AT THE CENTER OF THE CONNECTOR. **FIGURE 6**
3. INSERT THE TERMINAL FROM THE **GRAY** CRUISE HARNESS SUPPLIED IN KIT TO PIN **23**. (FOR REFERENCE; PIN 1 GREEN/BLUE; PIN 2 GREEN/BLACK; PIN 16 GREEN/WHITE OR BLACK/RED). **FIGURE 7**
4. **BE SURE TO PRESS IN RETAINER BEFORE CONNECTING TO PCM.**

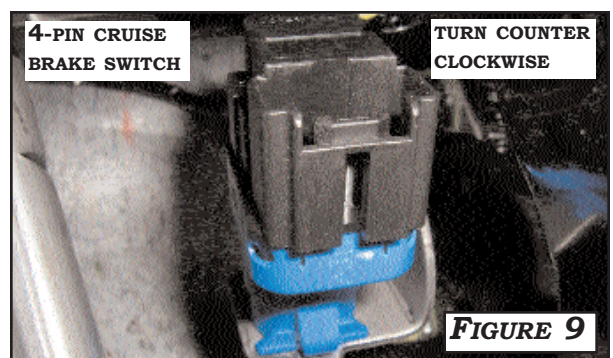
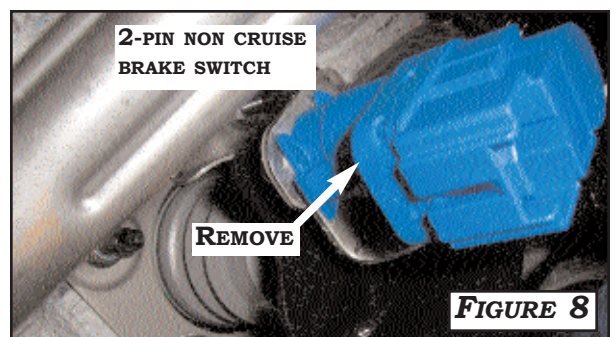
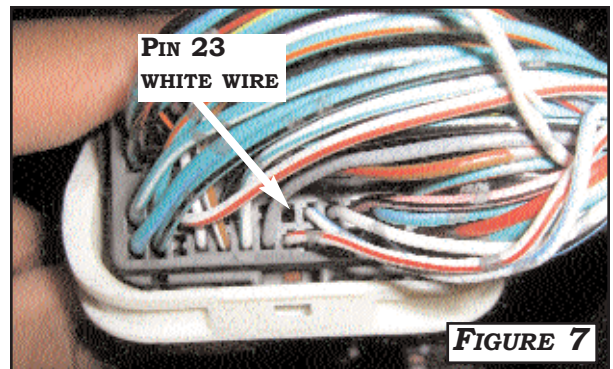
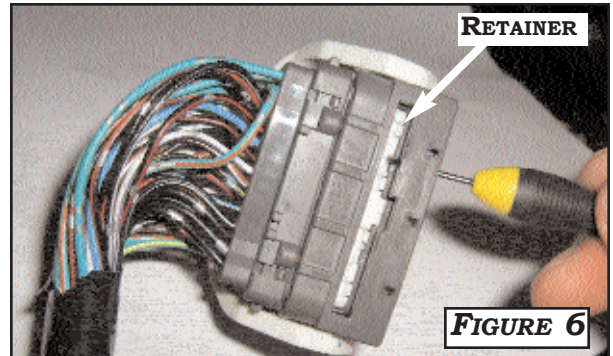
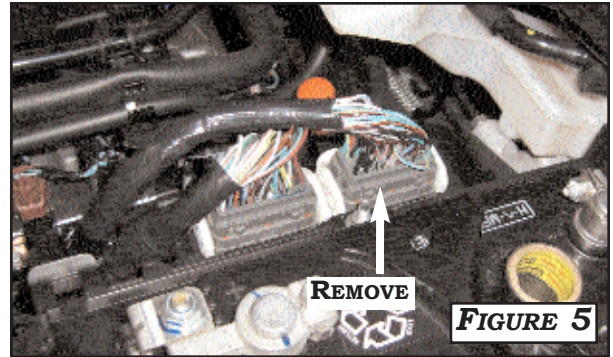

## D. BRAKE SWITCH INSTALLATION:

1. DISCONNECT THE CONNECTOR FROM THE BRAKE SWITCH. REMOVE THE 2-PIN BRAKE SWITCH BY TURNING CLOCK WISE AND THEN RELEASING. **FIGURE 8**. REPLACE WITH 4-PIN CRUISE BRAKE SWITCH SUPPLIED IN KIT.
2. **CAUTION:** PRESS IN THE BRAKE PEDAL AND HOLD. WHEN INSTALLING THE BRAKE SWITCH POSITION THE SWITCH IN THE DIAGONAL HOLE OF THE BRACKET SO THAT THE SWITCH CAN BE TURNED COUNTER CLOCKWISE. RELEASE THE BRAKE PEDAL IN AT REST AND TURN THE BRAKE SWITCH COUNTER CLOCKWISE TO LOCK THE SWITCH INTO PLACE. **FIGURE 9**. **BE SURE TO CHECK THE FOLLOWING READINGS WITH AN OHMMETER BEFORE DRIVE TESTING:**

### INNER BRAKE SWITCH TERMINALS

1. PEDAL AT REST- 0.01OHM CONTINUITY
2. PEDAL PRESSED- OPEN CIRCUIT

### OUTER BRAKE SWITCH TERMINALS

1. PEDAL AT REST- OPEN CIRCUIT
2. PEDAL PRESSED- 0.01OHM CONTINUITY

**NOTE: IF THE BRAKE SWITCH READINGS ARE ANY DIFFERENT THAN ABOVE OR NOT INSTALLED PROPERLY, PRESSING THE BRAKE WILL NOT CANCEL THE CRUISE.**

# INSTALLATION

## D. BRAKE SWITCH INSTALLATION (CONT.) :

2. REPLACE CONNECTOR. CONNECT THE **GREEN WIRE** MARKED **CRUISE 2** AND THE **BLACK WIRE** OF THE MAIN CRUISE HARNESS TO THE **BLACK GROUND WIRE** AT THE BRAKE SWITCH CONNECTOR. **FIGURE 10**

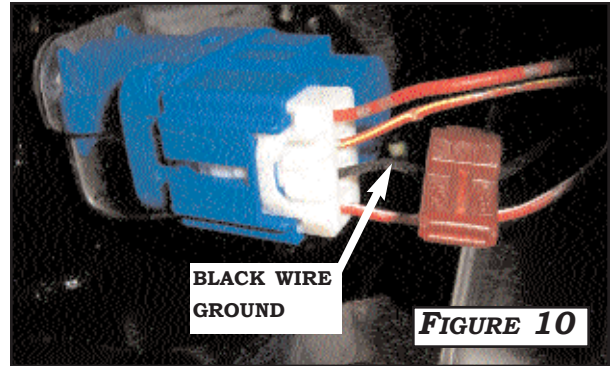

## E. CONTROL SWITCH INSTALLATION:

1. MARK HOLE AS SHOWN IN **FIGURE 10**. USE THE **LEVER WEDGE** AS AN ANGLE TEMPLATE TO DRILL **9.5MM OR 3/8"** HOLE IN LOWER SHROUD. POSITION THE LOCKWASHERS AS SHOWN IN **FIGURE 11**. START NUT AND POSITION THE LETTERING FOR DRIVER'S BEST VIEW. FULLY SECURE NUT AT **2.5-2.8Nm. Do NOT OVERTIGHTEN.**
2. LOCATE THE 4 PIN CONNECTOR IN HARDWARE KIT. **FIGURE 12**. INSTALL 4 PIN CONNECTOR ON **RED, BROWN, GREEN, AND YELLOW** SWITCH WIRES. **FIGURE 13**. **DO NOT USE THE BLACK AND BLUE WIRES FROM SWITCH HARNESS. WRAP THESE REMAINING WIRES WITH ELECTRICAL TAPE.**
3. CONNECT SWITCH HARNESS TO MAIN CRUISE HARNESS. VERIFY THAT ALL COLORS MATCH. CONNECT MAIN CRUISE HARNESS TO CRUISE CONTROL MODULE.

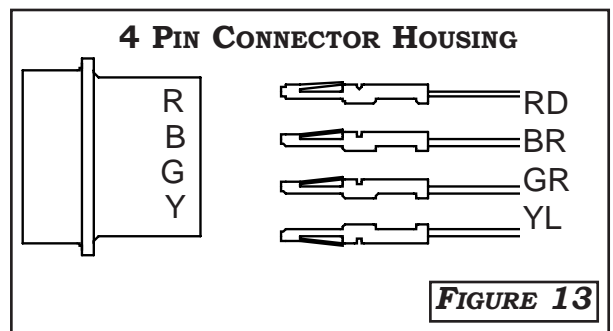
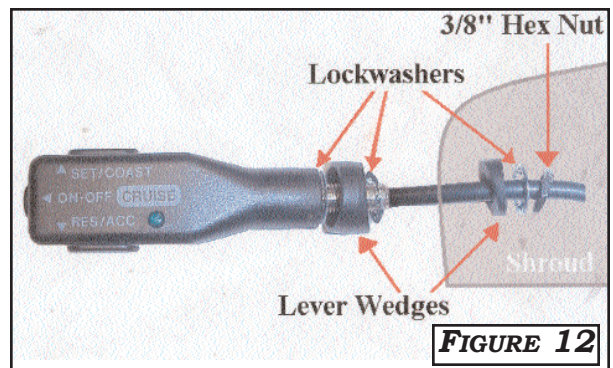
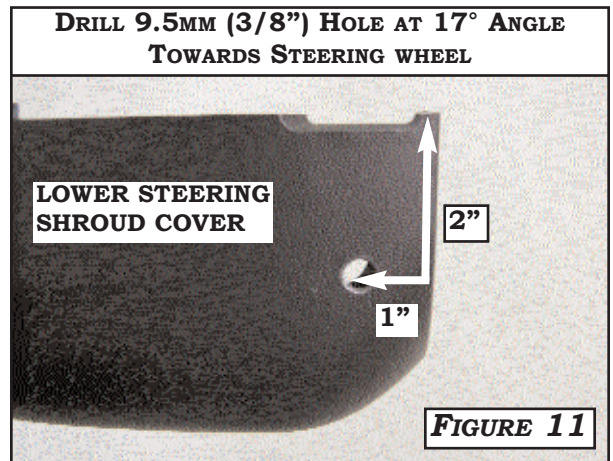

**CAUTION: Do NOT USE THE BLACK AND BLUE WIRES FROM THE CONTROL SWITCH. WRAP WIRES WITH ELECTRICAL TAPE**

# INSTALLATION

## F. REASSEMBLY:

1. REINSTALL ALL REMOVED PARTS FROM VEHICLE.
2. SECURE ALL WIRES WITH WIRE TIES.
3. RECONNECT NEGATIVE BATTERY CABLE.

## G. TESTING:

1. TEST CRUISE FUNCTIONS IN ACCORDANCE WITH OPERATING INSTRUCTIONS. THE “CRUISE” INDICATOR LIGHT WILL ACTIVATE IN THE INSTRUMENT CLUSTER WHEN CONTROL SWITCH IS TURNED ON. **FIGURE 14.** THE CONTROL SWITCH INDICATOR LIGHT WILL NOT ILLUMINATE FOR THIS APPLICATION.

**IMPORTANT: VERIFY CRUISE DISENGAGES WHEN VEHICLE IS PUT IN NEUTRAL OR BRAKE IS DEPRESSED.**

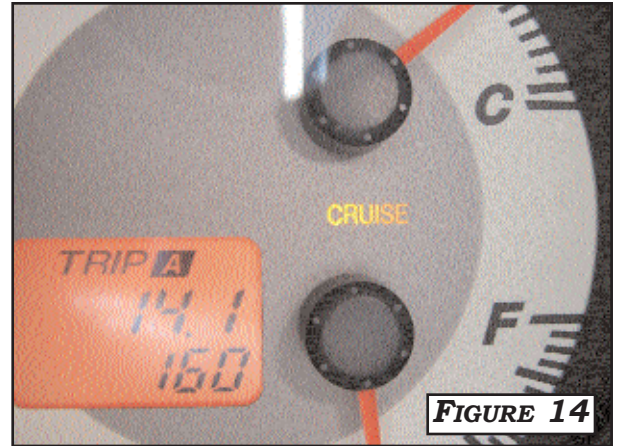

# WIRING DIAGRAM

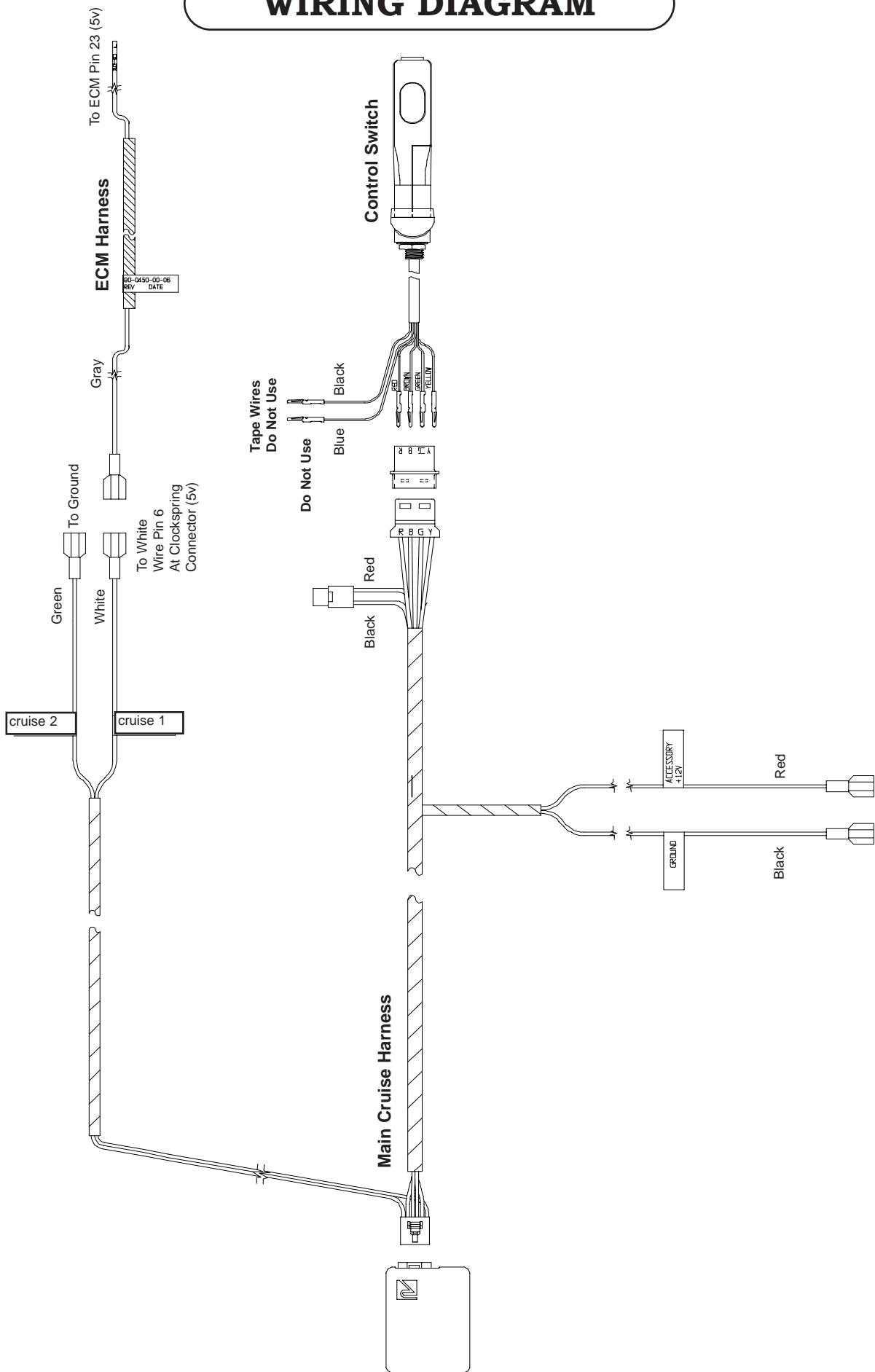

# NOTES



**ROSTRA.COM**