

08-11 DODGE CARAVAN, NITRO, JOURNEY
 CHRYSLER TOWN & COUNTRY/ JEEP LIBERTY
 09-11 DODGE RAM 1500/ DAKOTA NEW BODY

CRUISE CONTROL SWITCH

PART NUMBER: 250-9001

KIT CONTENTS

| ITEM | QTY | DESCRIPTION |
|------|-----|-------------------------------|
| 1 | 1 | CRUISE CONTROL SWITCH/HARNESS |
| 2 | 1 | ECM HARNESS |
| 3 | 1 | HARDWARE PACKAGE |
| 4 | 1 | CLOCKSPRING HARNESS |

SERVICE PARTS

| ITEM | QTY | DESCRIPTION | PART NUMBER |
|------|-----|-------------------------|-------------|
| 1 | 1 | CONTROL SWITCH | 250-2716 |
| 2 | 1 | CLOCKSPRING/ECM HARNESS | 250-2728 |
| 3 | 1 | HARDWARE PACKAGE | 250-2714 |

HARDWARE PACKAGE CONTENTS

| ITEM | QTY | DESCRIPTION |
|------|-----|-------------------------------|
| 1 | 2 | #10 SCREWS, T-25 |
| 2 | 3 | POSI-TAP CONNECTORS |
| 3 | 1 | CONVOLUTED TUBING, 3/6 INCHES |
| 4 | 5 | CABLE TIES |
| 5 | 3 | #6 SCREWS, T-15 |

ADDITIONAL ITEMS REQUIRED FOR INSTALL

| ITEM | QTY | DESCRIPTION |
|------|-----|-----------------|
| 1 | N/A | ELECTRICAL TAPE |
| 2 | | |
| 3 | | |
| 4 | | |

CONFLICTS

NOTE:

RECOMMENDED TOOLS

| | |
|---------------------------|----------------------|
| SAFETY TOOLS | |
| | |
| | |
| SPECIAL TOOLS | |
| | |
| | |
| INSTALLATION TOOLS | |
| FASTENER REMOVAL TOOL | WIRE CUTTERS |
| TRIM REMOVAL TOOL | PHILLIPS SCREWDRIVER |
| 10-MM DEEP SOCKET | PLIERS |
| T15 DRIVER | T25-DRIVER |
| | |
| SPECIAL CHEMICALS | |
| | |

COLOR APPLICABILITY/TRIM LEVEL

| ACCESSORY COLOR | | | | | | | | | | | | | | | | | | | | | |
|--------------------|--|--|--|--|--|--|--|--|--|--|--|--|--|--|--|--|--|--|--|--|--|
| VEHICLE TRIM COLOR | | | | | | | | | | | | | | | | | | | | | |
| | | | | | | | | | | | | | | | | | | | | | |
| | | | | | | | | | | | | | | | | | | | | | |

GENERAL APPLICABILITY







ALL MODELS

RECOMMENDED SEQUENCE OF APPLICATION

| |
|--|
| VEHICLE PREPARATION ... PAGE 2 |
| ECM HARNESS CONNECTIONS ... PAGE 3 |
| CONTROL SWITCH ... PAGE 4 |
| REASSEMBLY AND VEHICLE TEST ... PAGE 5 |

* MANDATORY

LEGEND

| | |
|---|--|
|  | STOP: DAMAGE TO VEHICLE MAY OCCUR. DO NOT PROCEED UNTIL PROCESS COMPLIANCE HAS BEEN MET. |
|  | OPERATOR SAFETY: USE CAUTION TO AVOID RISK OF INJURY. |
|  | CRITICAL PROCESS: PROCEED WITH CAUTION TO ENSURE A QUALITY INSTALLATION. THESE POINTS WILL BE AUDITED ON A COMPLETED VEHICLE INSTALLATION. |
|  | GENERAL PROCESS: THIS HIGHLIGHTS SPECIFIC PROCESSES TO ENSURE A QUALITY INSTALLATION. THESE POINTS WILL BE AUDITED DURING THE ACCESSORY INSTALLATION. |
|  | TOOLS & EQUIPMENT: THIS CALLS OUT THE SPECIFIC TOOLS AND EQUIPMENT REQUIRED FOR THE PROCESS. |
|  | REVISION MARK: THIS MARK HIGHLIGHTS A CHANGE IN INSTALLATION WITH RESPECT TO PREVIOUS ISSUE. |

SPECIAL NOTE: INSTALLATION SEQUENCES

AFTER SAFETY MANDATED PREPARATORY STEPS HAVE BEEN TAKEN, THE INSTALLATION SEQUENCE IS THE SUGGESTED METHOD FOR COMPLETING THE ACCESSORY INSTALLATION. IN SOME INSTANCES THE SUGGESTED SEQUENCE IS WRITTEN FOR ONE ASSOCIATE TO INSTALL AND IN OTHERS THE SEQUENCE IS GIVEN AS PART OF A TEAM ACCESSORY INSTALLATION. UNLESS OTHERWISE STATED IN THE DOCUMENT, THE ASSOCIATES MAY PERFORM THE INSTALLATION STEPS IN ANY ORDER TO MAKE THE INSTALLATION AS EFFICIENT AS POSSIBLE WHILE MAINTAINING CONSISTENT QUALITY.

VEHICLE PREPARATION

DODGE RAM 1500 / DAKOTA NEW BODY

1. DISCONNECT THE CABLE FROM THE NEGATIVE TERMINAL OF THE BATTERY. **FIGURE 1**



CAUTION: ENSURE THAT BATTERY HAS BEEN DISCONNECTED FOR MORE THAN 90 SECONDS PRIOR TO REMOVAL OF AIRBAG; FAILURE TO HEED THIS WARNING MAY RESULT IN AIRBAG DISCHARGE AND MAY CAUSE SERIOUS INJURY OR DEATH.

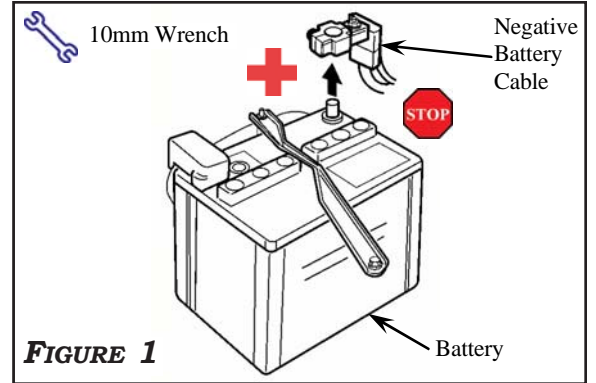

2. REMOVE LOWER DASH PANEL BY REMOVING (2) PHILLIPS SCREWS AS SHOWN IN **FIGURE 2**.

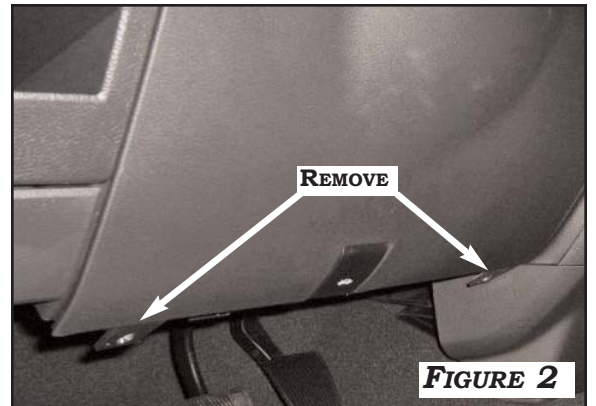

3. REMOVE (3) T20 SCREWS TO REMOVE THE STEERING SHROUD AS SHOWN IN **FIGURE 3**.

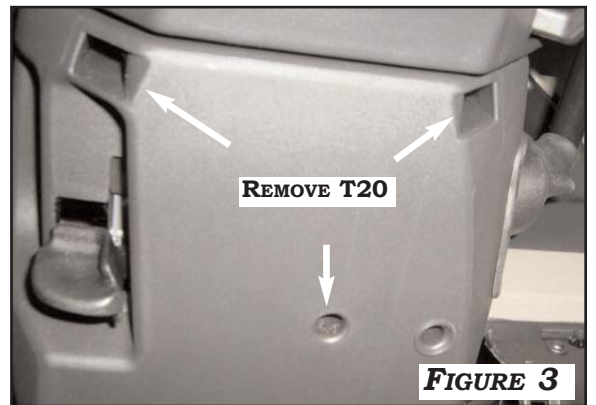

4. LOCATE THE (3) METAL CLIPS BEHIND THE STEERING WHEEL. USE A MIRROR FOR A BETTER VIEW AS AN OPTION. **FIGURE 4**

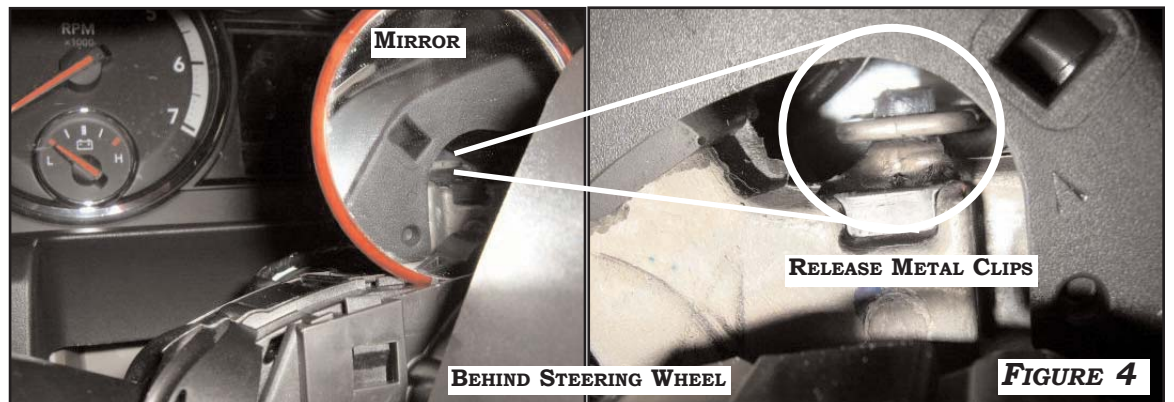

VEHICLE PREPARATION

DODGE RAM 1500 / DAKOTA NEW BODY CONTINUED...

5. PLACE A FLAT HEAD SCREWDRIVER BELOW EACH CLIP AND TWIST WHILE PULLING THE AIR BAG FORWARD TO RELEASE.

FIGURE 5

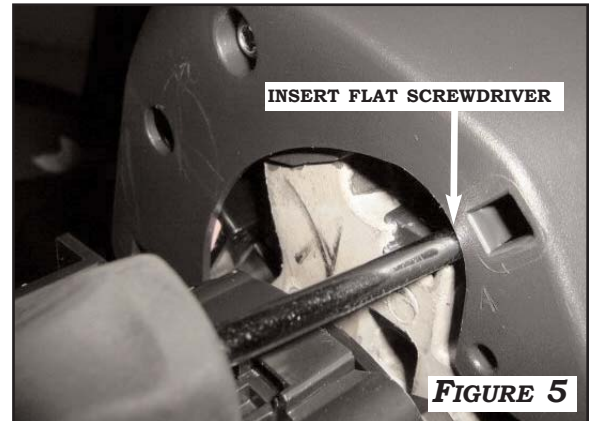

6. PRESS IN SIDES OF BOTH CONNECTORS TO REMOVE AIRBAG AS SHOWN IS FIGURE **FIGURE 6**

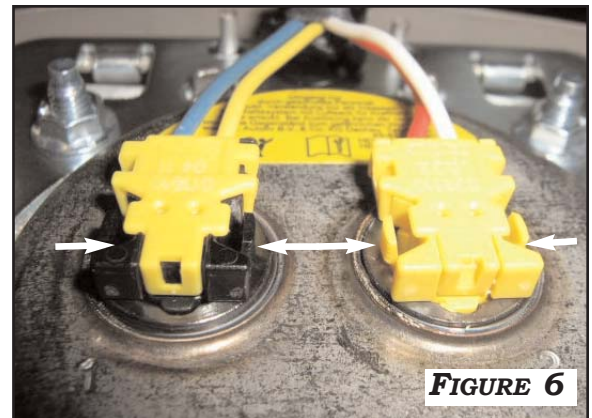

CAUTION: BE SURE TO STORE AIRBAG FACE UP AS ILLUSTRATED IN FIGURE 7 TO REDUCE INJURY IN EVENT OF ACCIDENTAL DISCHARGE OF AIRBAG.

STORE AIRBAG FACE UP AS ILLUSTRATED BELOW

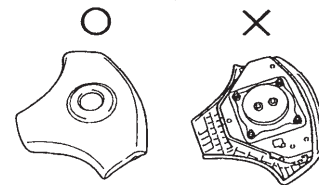

FIGURE 7

INSTALLATION

CONTROL SWITCH

(DODGE RAM 1500/DAKOTA NEW BODY)



1. MEASURE 3/4" DOWN FROM THE BACK SIDE TOP CORNER AND 1/4" IN FROM THE OUTER EDGE TO CUT CLEARANCE FOR SWITCH AT RIGHT SIDE OF STEERING COLUMN. **FIGURES 8 & 9.**

2. USE (2) #10, T25 SCREWS PROVIDED IN HARDWARE BAG TO MOUNT CRUISE CONTROL SWITCH. **FIGURES 10 & 11**

3. **FOR SWITCH WITH HARNESS CONNECTOR:** REMOVE FACTORY 6-PIN CONNECTOR OF VEHICLE AND EXTRACT **PINS 2 AND 3 (HORN)**. **FIGURE 12.** REPLACE FACTORY CONNECTOR WITH ROSTRA SWITCH CONNECTOR. CONNECT REMAINING TWO WIRES FROM ROSTRA SWITCH CONNECTOR TO WIRES THAT WERE EXTRACTED FROM FACTORY CONNECTOR. **FOR SWITCH WITH HARNESS TERMINALS:** LOCATE WHITE 6 PIN CONNECTOR INSIDE STEERING WHEEL. INSERT CRUISE CONTROL HARNESS WIRES TO THE FOLLOWING PIN LOCATIONS IN BACK-SIDE OF CONNECTOR: **PINK WIRE TO PIN 4; YELLOW WIRE TO PIN 5; VIOLET WIRE TO PIN 6.** CONNECT BLACK 3 PIN CONNECTOR OF CRUISE CONTROL HARNESS TO CRUISE CONTROL SWITCH. **FIGURE 13**

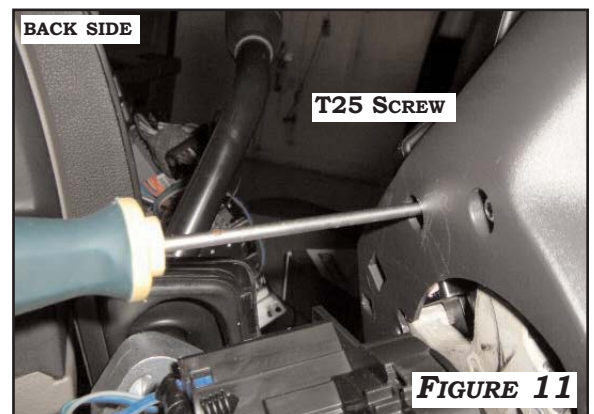
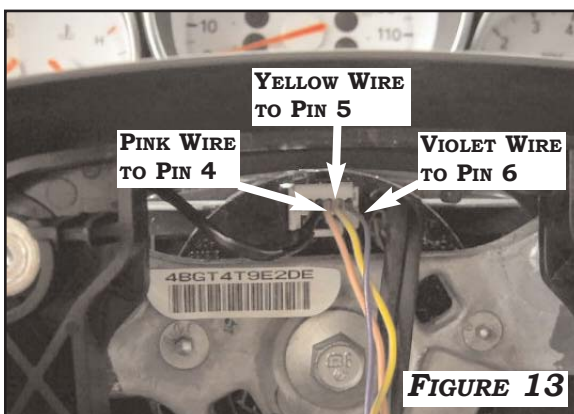
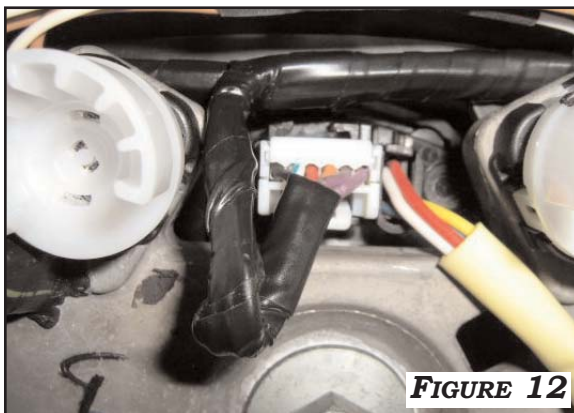
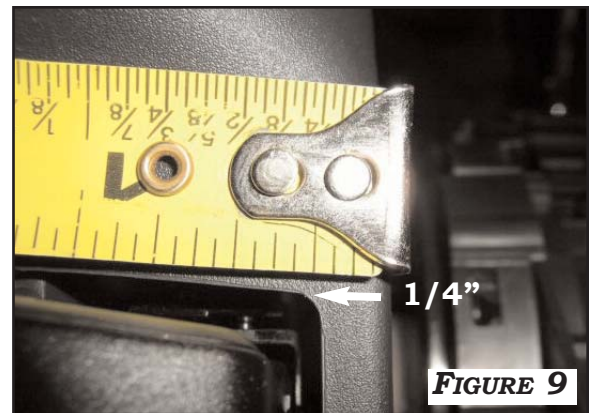

VEHICLE PREPARATION

DODGE NITRO, CARAVAN, JOURNEY,
TOWN & COUNTRY, AND JEEP LIBERTY



1. REMOVE THE NEGATIVE BATTERY CABLE BEFORE INSTALLING THE CRUISE CONTROL COMPONENTS FOR SAFETY PRECAUTIONS.
2. REMOVE STEERING COLUMN SHROUD. REMOVE AIRBAG BY USING FLAT HEAD SCREWDRIVER TO RELEASE (3) METAL CLIPS AS SHOWN IN **FIGURES 1,2.**



CAUTION: ENSURE THAT BATTERY HAS BEEN DISCONNECTED FOR MORE THAN 90 SECONDS PRIOR TO REMOVAL OF AIRBAG; FAILURE TO HEED THIS WARNING MAY RESULT IN AIRBAG DISCHARGE AND MAY CAUSE SERIOUS INJURY OR DEATH.

3. PRESS IN SIDES OF BOTH CONNECTORS TO REMOVE AIRBAG AS ILLUSTRATED IN **FIGURE 3.**



CAUTION: BE SURE TO STORE AIRBAG FACE UP AS ILLUSTRATED IN **FIGURE 3A** TO REDUCE INJURY IN EVENT OF ACCIDENTAL DISCHARGE OF AIRBAG.

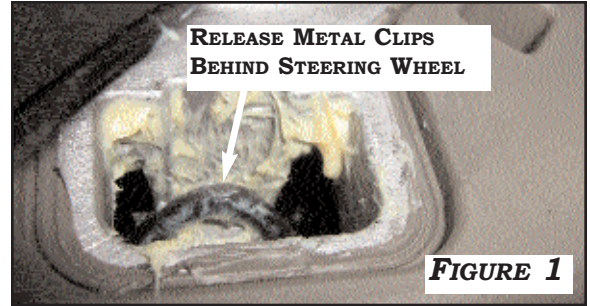

FIGURE 1

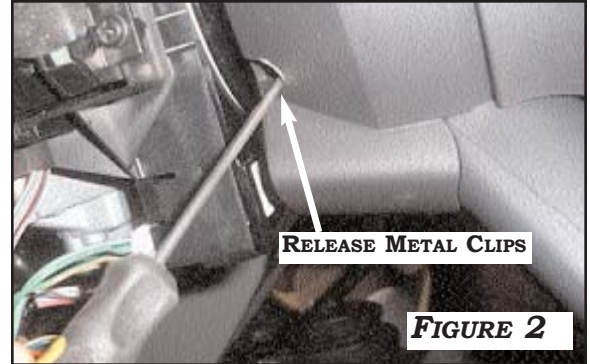

FIGURE 2

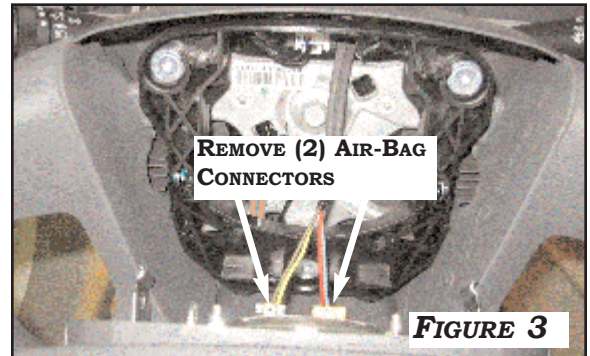

FIGURE 3

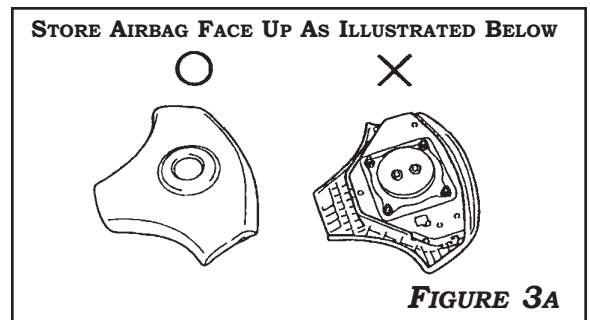

FIGURE 3A

INSTALLATION

CLOCKSPRING/ECM HARNESS



1. SOME VEHICLES ARE PREWIRED FOR CRUISE. VERIFY ECM POSITIONS ARE OCCUPIED. IF OCCUPIED, SKIP TO CRUISE SWITCH INSTALLATION.

2. **DODGE CARAVAN, JOURNEY, AND TOWN & COUNTRY** APPLICATIONS: LOCATE FOUR CONNECTOR ECM AT DRIVER SIDE FENDER WELL BEHIND SPLASH GUARD AT FRONT WHEEL. **DODGE NITRO AND JEEP LIBERTY** APPLICATIONS: LOCATE ECM AT PASSENGER SIDE FENDER WELL. GO TO THIRD CONNECTOR (WHITE ON BOTTOM SIDE). **FIGURE 4**. REMOVE TOP OF CONNECTOR. LOCATE **PIN 15 VIOLET/BROWN WIRE, PIN 18 VIOLET/ORANGE WIRE, AND PIN 34 VIOLET WIRE. FIGURE 5**. IF WIRES ARE PRESENT, THEN VEHICLE IS PREWIRED. SKIP TO CONTROL SWITCH INSTALLATION. IF WIRES ARE NOT IN THE POSITIONS, USE **CLOCKSPRING/ECM HARNESS** SUPPLIED IN KIT.

3. RELEASE SLOT CLIP TO FREE PINS IN CONNECTOR. USE PRECISION TOOL TO BREAK PLASTIC INSERT IN OPENING OF **PIN 15, 18 AND 34** OF CONNECTOR (**FIGURE 6**). PUSH OUT REMAINS ON REVERSE SIDE AS SHOWN IN **FIGURE 7**.



CAUTION: BE SURE PLASTIC INSERT IS FULLY REMOVED BEFORE INSERTING EACH PIN.

4. INSERT **PINK** CRUISE WIRE TO **PIN 18** OF ECM, **VIOLET** CRUISE WIRE TO **PIN 34**, AND **YELLOW** CRUISE WIRE TO **PIN 15**. ONCE PINS ARE INSERTED, RE-ASSEMBLE CONNECTOR. ROUTE THE CLOCKSPRING/ECM HARNESS INSIDE VEHICLE TO STEERING COLUMN. LOOK BELOW STEERING COLUMN. LOCATE FAR RIGHT CLOCKSPRING CONNECTOR. **FIGURE 8**. USING **CLOCKSPRING/ECM HARNESS** IN KIT, INSERT **PINK** CRUISE WIRE TO **PIN 4**, **YELLOW** CRUISE WIRE TO **PIN 5**, AND **VIOLET** CRUISE WIRE TO **PIN 6. FIGURE 8A**

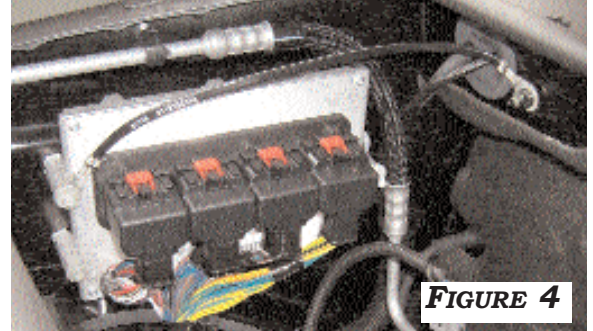

FIGURE 4

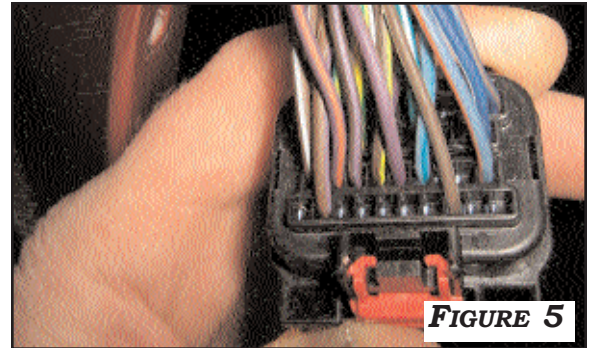

FIGURE 5

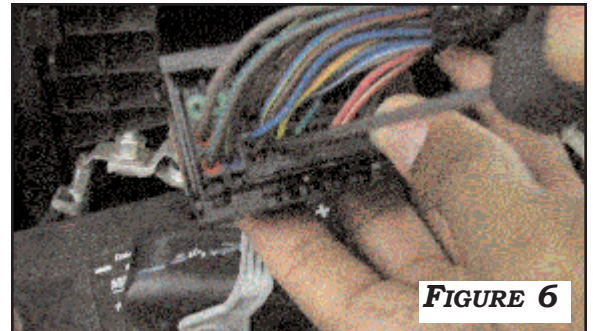

FIGURE 6

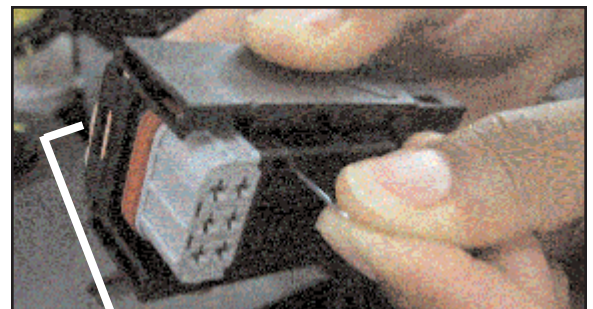

FIGURE 7

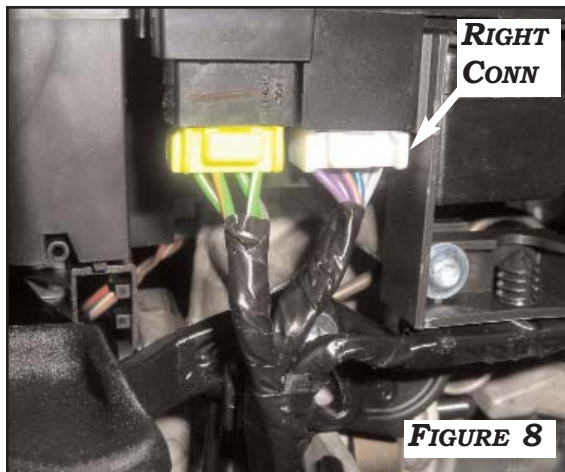

FIGURE 8

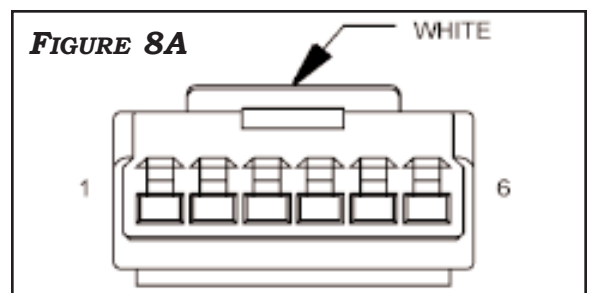

FIGURE 8A

INSTALLATION

CONTROL SWITCH (DODGE CARAVAN, JOURNEY, JEEP LIBERTY, AND TOWN & COUNTRY)



1. CUT CLEARANCE FOR SWITCH AT RIGHT SIDE OF STEERING COLUMN. FOR DODGE CARAVAN, JOURNEY, JEEP LIBERTY, AND TOWN & COUNTRY USE **FIGURE 9**. FOR DODGE NITRO USE **FIGURE 10**.
2. USE (2) #10, T25 SCREWS PROVIDED IN HARDWARE BAG TO MOUNT CRUISE CONTROL SWITCH. **FIGURE 11**
3. LOCATE WHITE 6 PIN CONNECTOR INSIDE STEERING WHEEL. INSERT CRUISE CONTROL HARNESS WIRES TO THE FOLLOWING PIN LOCATIONS IN BACK-SIDE OF CONNECTOR: **PINK WIRE TO PIN 4; YELLOW WIRE TO PIN 5; VIOLET WIRE TO PIN 6**. CONNECT BLACK 3 PIN CONNECTOR OF CRUISE CONTROL HARNESS TO CRUISE CONTROL SWITCH. **FIGURE 12**

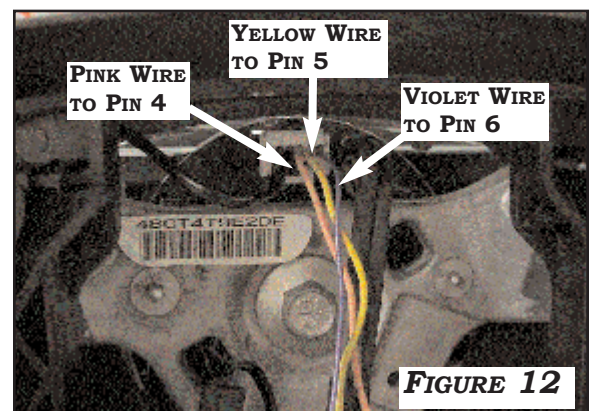
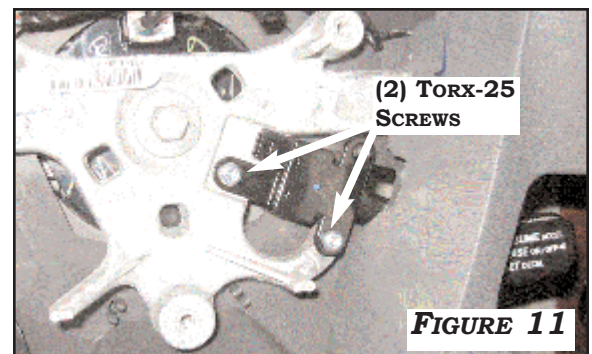
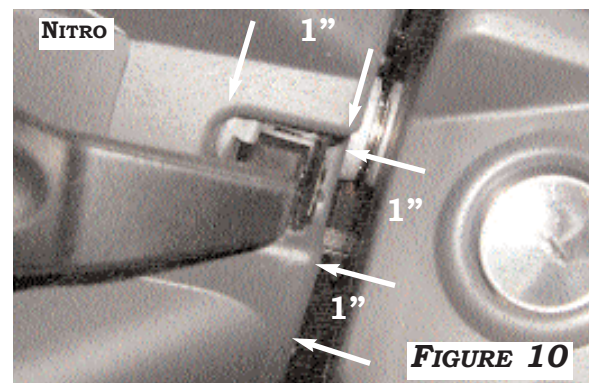
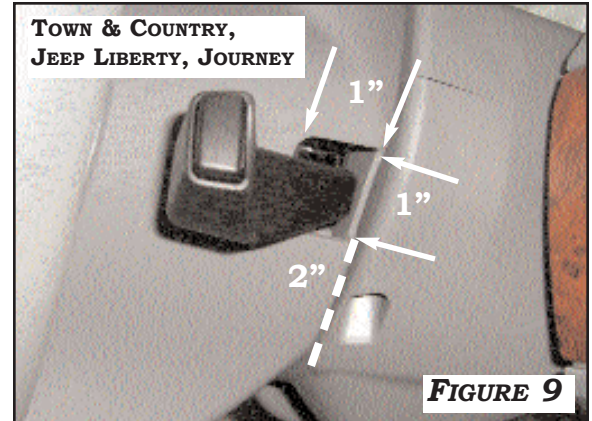

INSTALLATION

REASSEMBLY



1. REINSTALL AIRBAG.
2. RECONNECT NEGATIVE BATTERY CABLE AND TORQUE NUT TO **35 FT*LBS.**

TESTING

WHILE DRIVING VEHICLE, PRESS **[ON/OFF]** BUTTON ON CRUISE SWITCH TO ENGAGE CRUISE CONTROL. WITH VEHICLE ABOVE MINIMUM SET SPEED (REFER TO OWNER'S MANUAL), VERIFY THE FOLLOWING:

1. PRESSING **[SET]** ON CRUISE SWITCH CAUSES CRUISE TO CONTROL VEHICLE AT DESIRED SPEED.
2. PRESSING VEHICLE'S **BRAKE** PEDAL OR SHIFTING INTO NEUTRAL RETURNS CONTROL OF VEHICLE SPEED TO DRIVER.
3. PRESSING **[RESUME]** ON CRUISE SWITCH CAUSES CRUISE TO RETURN VEHICLE TO DESIRED SPEED.
4. PRESSING **[CANCEL]** ON CRUISE SWITCH RETURNS CONTROL OF VEHICLE SPEED TO DRIVER. PRESSING **[RESUME]** ON CRUISE SWITCH CAUSES CRUISE TO RETURN VEHICLE TO DESIRED SPEED.
5. PRESSING **[ON/OFF]** TURNS OFF CRUISE AND RETURNS CONTROL OF VEHICLE SPEED TO DRIVER. PREVIOUSLY SET SPEED IS REMOVED FROM CRUISE'S MEMORY.

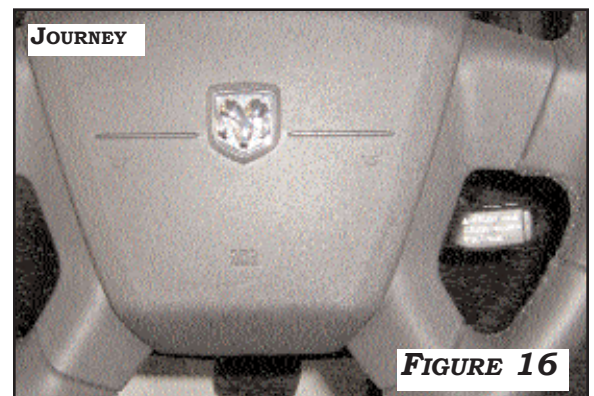
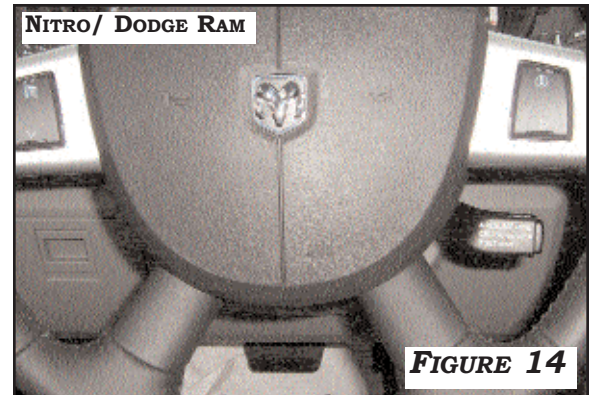
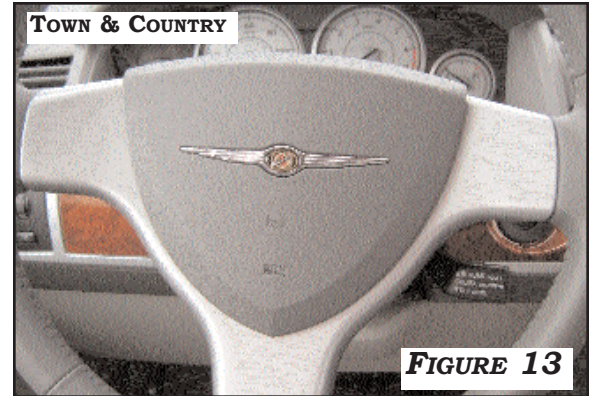

TROUBLESHOOTING

2. CHECK CONTINUITY FROM ECM TO CONNECTOR AT STEERING WHEEL. IF NO CONTINUITY, CHECK CONNECTIONS UNDER STEERING COLUMN AT BACK OF OF CLOCK-SPRING. THEN CHECK CONTINUITY FROM CLOCKSPRING CONNECTOR TO STEERING WHEEL CONNECTOR.

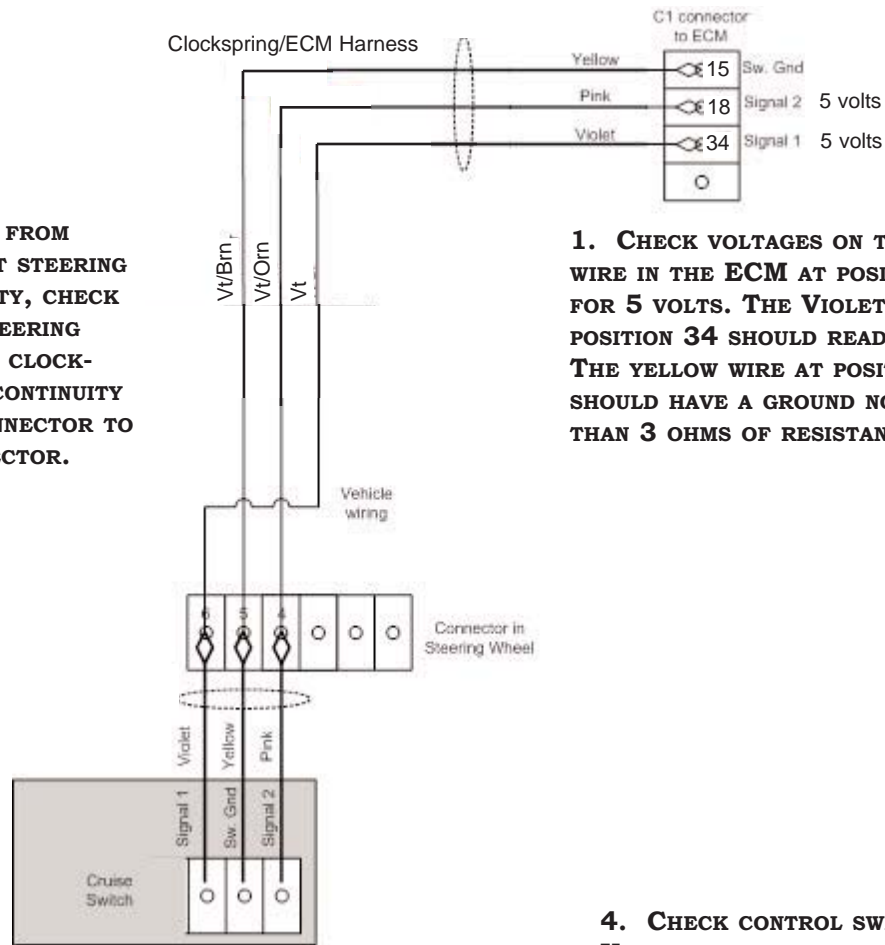

1. CHECK VOLTAGES ON THE PINK WIRE IN THE ECM AT POSITION 18 FOR 5 VOLTS. THE VIOLET WIRE AT POSITION 34 SHOULD READ 5 VOLTS. THE YELLOW WIRE AT POSITION 15 SHOULD HAVE A GROUND NO HIGHER THAN 3 OHMS OF RESISTANCE.

3. CHECK CONTROL SWITCH VOLTAGE. LOCATE 6-PIN CONNECTOR AT STEERING WHEEL AND MEASURE VOLTAGE ACROSS THE FOLLOWING WIRES LISTED BELOW:

VIOLET WIRE PIN 6 TO Vt/BRN (YELLOW) WIRE PIN 5

**PRESS SET=3.35 VOLTS
PRESS RESUME=4.0 VOLTS
PRESS ON/OFF=0.90 VOLTS
PRESS CANCEL=1.80 VOLTS**

Vt/ORN (PINK) WIRE PIN 4 TO Vt/BRN (YELLOW) WIRE PIN 5

**PRESS SET=1.35 VOLTS
PRESS RESUME=2.25 VOLTS
PRESS ON/OFF=3.75 VOLTS
CANCEL=3.0 VOLTS**

4. CHECK CONTROL SWITCH. UNPLUG CONNECTOR AT THE STEERING WHEEL AND MEASURE RESISTANCE ACROSS THE FOLLOWING WIRES LISTED BELOW:

PINK -PURPLE

ON/OFF: 6.6 Ohms
SET: 5.13 Ohms
RESUME: 10.50 Ohms
CANCEL: 4.46 Ohms

PINK-YELLOW

ON/OFF: 6.2 Ohms
SET: 0.79 Ohms
RESUME: 1.7 Ohms
CANCEL: 3.2 Ohms

PURPLE-YELLOW

ON/OFF: 0.46 Ohms
SET: 4.35 Ohms
RESUME: 8.80 Ohms
CANCEL: 1.16

NOTES



ROSTRA.COM